



## COLOUR TELEVISION

**AV-2988SE**  
**AV-2986ME**  
**AV-2986SE**  
**AV-2956BE**  
**AV-2956ME**

**AV-2586ME**

**AV-2186ME**  
**AV-2156BE**  
**AV-2156ME**

EQUALIZER • CINEMA SURROUND • COMPONENT INPUT

### Contents

Knowing your TV's features .....	3
Remote control buttons and basic functions .....	4
TV buttons and functions.....	6
Setting up your TV.....	7
Basic setting for picture .....	9
Advanced setting for picture.....	11
Original features for picture .....	12
Basic setting for sound .....	14
Advanced setting for sound.....	15
DVD Menu .....	16
Customized setting.....	17
TV channel presetting .....	19
Additional preparation .....	22
Troubleshooting.....	23
Specifications .....	Back cover

## INSTRUCTIONS

Thank you for buying this JVC colour television.  
To make sure you understand how to use your new TV, please read this manual thoroughly before you begin.

**WARNING: TO PREVENT FIRE OR SHOCK HAZARD, DO NOT EXPOSE THIS APPLIANCE TO RAIN OR MOISTURE.**

**CAUTION: TO ENSURE PERSONAL SAFETY, OBSERVE THE FOLLOWING RULES REGARDING THE USE OF THIS TV.**

- 1 Operate only from the power source indicated on the rear of the TV.
- 2 Avoid damaging the power cord and mains plug. When unplugging the TV, grasp the mains plug. Do not pull on the power cord.
- 3 Never block or cover the ventilation openings.  
Never install the TV where good ventilation is unattainable.  
When installing this TV, leave spaces for ventilation around the TV of more than the minimum distances as shown.

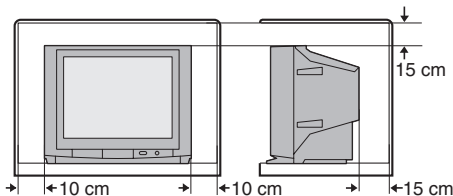

- 4 Do not allow objects or liquid into the cabinet openings.
- 5 In the event of a fault, unplug the unit and call a service technician.  
Do not attempt to repair it yourself or remove the rear cover.
- 6 The surface of the TV screen is easily damaged. Be very careful with it when handling the TV. Should the TV screen become soiled, wipe it with a soft dry cloth. Never rub it forcefully. Never use any cleaner or detergent on it.

- 7 This TV can be turned on/off power by connecting/disconnecting the AC plug into AC outlet. While this TV is being installed, enough space should be reserved for connection/disconnecting the AC plug into AC outlet by hand.

- 8 The apparatus shall not be exposed to dripping or splashing and that no objects filled with liquids, such as vases, shall be placed on the apparatus.

**WARNING: <AV-21M, AV-25M, AV-29M, AV-21B, AV-29B Series>  
YOU CAN DETACH THE PROTECT SHEET ON THE TOP AND BOTTOM OF FRONT FRAME IF YOU NEEDED.  
THE FRONT BUTTON DOOR OF THE TV SHOULD BE PULLED OUT FROM ITS BOTTOM. DO NOT PRESS THE UPPER PART, OR YOUR FINGER MAY BE PINCHED.**

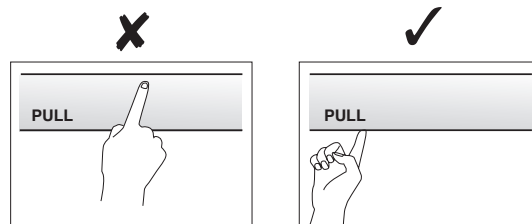

# Knowing your TV's features

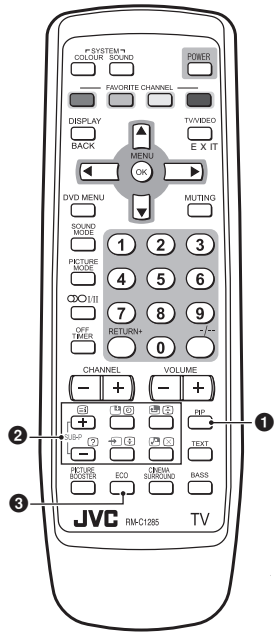

## Main features

<b>DVD MENU</b>	Just connect DVD player to the television. The television will detect DVD signal and display picture on the screen automatically and you can adjust pictures and sound while you are watching DVD as your desire. When disconnect DVD player, the television will display the previous channel.
<b>MaxxBass</b>	MaxxBass enhances bass sound that cannot be reproduced by normal speakers to be heard by our ears.
<b>PIP (Picture In Picture)</b>	You can view two screens (Main picture and Sub picture) at the same time.
<b>TELETEXT</b>	You can view teletext programmes which are broadcasted by some TV channels. Teletext programme is an information in text form.
<b>FAVORITE CH (Channel)</b>	You can register up to four favorite channels for quick recall with one press.
<b>A2/NICAM (STEREO / I-II)</b>	You can listen the stereo sound or bilingual sound from TV programme broadcasting by A2 or NICAM Sound-multiplex system.
<b>AI ECO SENSOR</b>	TV detects the brightness of your room and automatically adjust the picture brightness to a suitable level for a better eyecare.
<b>ECO MODE</b>	You can adjust TV screen contrast according to the brightness of your room to suitable level for a better eyecare.
<b>AI VOLUME</b>	TV adjusts the volume automatically to the same level for all TV channels to avoid sudden change of the volume when selecting different TV channels or selecting Video Mode.
<b>TINT</b>	You can adjust TINT setting for all colour systems, including PAL.

## Confirm your TV's functions

Some functions written in this instruction manual may not be available for your TV.

Please see the chart below and check the functions that are equipped for your TV's model number.

The model number is indicated at the rear of your TV. When you press a button concerned to a function that is not available for your TV, it does not work and the logo "Ø" appears on the screen.

No.	Function	Model No.									
		AV-2988SE	AV-2986ME	AV-2986SE	AV-2956BE	AV-2956ME	AV-2586ME	AV-2186ME	AV-2156BE	AV-2156ME	
1, 2	PIP control buttons (Green label)	○	○	○	—	—	○	○	—	—	
—	MaxxBass	○	○	○	—	○	○	○	—	○	
—	PICTURE TILT	○	○	○	○	○	—	—	—	—	
3	AI ECO SENSOR	○	○	○	—	○	○	○	—	○	
3	ECO MODE	—	—	—	○	—	—	—	○	—	

# Remote control buttons and basic functions

No.	Press	To
①	POWER	Turn on or off the TV from standby mode.
②	MENU/OK	Display menu and confirm selected function.
③	▲ / ▼ / ◀ / ▶	Select and adjust menu function.
④	CHANNEL +/-	Select the desired channel number.
⑤	VOLUME +/-	Adjust the volume level.
⑥	TV/VIDEO EXIT	Select TV or video terminal input. On the other hand, you can use this button to EXIT from the menu.
⑦	MUTING	Turn off the volume. Press this button again to resume the volume.
⑧	DISPLAY /BACK	Display the programme number or video terminal number, stereo/bilingual broadcast system and PR list (channel list) on the screen. You can select the channel using the PR list. 1 Press the DISPLAY button once to display the PR list. 2 Press ▲ / ▼ / ◀ / ▶ buttons to choose a channel, then press the MENU/OK button. You can confirm the favorite channels in the PR list. The channels set to favorite channels are indicated with coloured mark.  On the other hand, you can use this button to return to the previous menu.
⑨	0~9, -/--	Select the programme number. For two digits programme number, press -/--, then press the number button.
⑩	RETURN+	a) Return to the frequently view channel with one touch. 1 Choose the channel you want to register. 2 Press and hold RETURN+ button until "RETURN PLUS PROGRAMMED!" appears. To cancel, press and hold RETURN+ button until "RETURN PLUS CANCELED!" appears. b) Return to the previously viewed channel, if you have not set or have cancelled the Return channel as above.
⑪	FAVORITE CHANNEL (colour buttons: red, green, yellow, blue)	Register and recall 4 favorite channels. 1. Choose the TV channel you want to register then press and hold a colour button until "PROGRAMMED! ■" appears. 2. To register other favorite channels, repeat step 1. To recall the favorite channel, press the corresponding colour button. When the TV is in Text function or MENU mode, the favorite channel function is not available. When the TV is in PIP function, the favorite channel function cannot register but can recall the favorite channel.

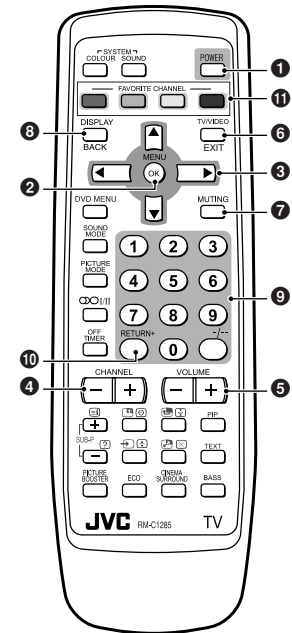

## Remote control buttons and basic functions (continued)

### How to operate menus and menu locations

To	Operation	Note
Display the MENU	Press the MENU/OK button ②. PICTURE MENU is displayed on first press.	To exit the MENU, press the DISPLAY/BACK button ③ or choose EXIT menu or TV/VIDEO/EXIT button ⑥.
Choose a Top menu	Press ◀/▶ buttons ③ to choose a menu title when the cursor is pointing at MENU.	—
Choose a 2nd menu	Press ▲/▼ buttons ③ to choose a 2nd menu title.	Press ▼ button ③ to display the next functions.
Display the 3rd menu	Press ▲/▼ buttons ③ to choose a 2nd menu title. Then press MENU/OK button ②.	
Return to the previous menu	Press the DISPLAY/BACK button ③.	—
Choose the setting of a function	Press ▲/▼ buttons ③ to choose a function. Then press the ◀/▶ buttons ③ to change the setting.	Press the TV/VIDEO/EXIT button ⑥ to exit from the menu.
Adjust the effect level of a function	Press ▲/▼ buttons ③ to choose a function. Then press the ◀/▶ buttons ③ to adjust the effect level.	
Display the sub menu of a function.	Press the ▲/▼ buttons ③ to choose a function. Then press MENU/OK button ② to display the sub menu.	—

The following chart shows locations of functions in menus. In this manual, location of a function is described as follows:

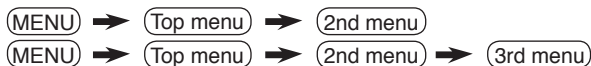

Note: Some functions have the 4th menus as the sub-menus.

	Top menu	2nd menu	Location	3rd menu	Location	
MENU	PICTURE	PICTURE MODE	P.9	—	—	
		PICTURE SETTING	P.10	CONTRAST	P.10	
				BRIGHT	P.10	
				SHARP	P.10	
				COLOUR	P.10	
		TINT	P.10			
	WHITE BALANCE	P.10	—	—		
	VNR	P.17	—	—		
	SOUND		STEREO/HI	P.15	—	—
			AI VOLUME	P.15	—	—
			SOUND MODE	P.14	—	—
			EQUALIZER	P.15	—	—
			BALANCE	P.14	—	—
			CINEMA SURROUND	P.15	—	—
			MaxxBass	P.15	—	—
	FEATURES	DVD MENU	P.16	AUTO SIGNAL DETECT	P.16	
				DVD PICTURE MODE	P.16	
				DVD THEATER STATUS	P.16	
				DVD SOUND MODE	P.16	
		ON TIMER	P.17	PR	P.17	
		ON TIMER	P.17	—	—	
		CHILD LOCK	P.17	—	—	
		COMPRESS (16:9)	P.11	—	—	
AI ECO SENSOR/ECO MODE		P.11	—	—		
INSTALL		AUTO PROGRAM	P.19	—	—	
	EDIT/MANUAL	P.19	DELETE, MOVE, MANUAL, INSERT	P.19-P.20		
	COLOUR SYSTEM	P.9	—	—		
	LANGUAGE	P.17	LANGUAGE	P.17		
	TEXT LANGUAGE	P.13	TEXT LANGUAGE	P.13		
	VIDEO-2 SETTING	P.18	—	—		
	BLUE BACK	P.11	—	—		
	PICTURE TILT	P.11	—	—		
BEEP	P.18	—	—			

# TV buttons and functions

The illustrations shown below is for AV-2156BE and AV-2988SE only, which are used for explanation purpose.  
Your TV may not look exactly the same as illustrated.

## Front of the TV

### AV-2988SE

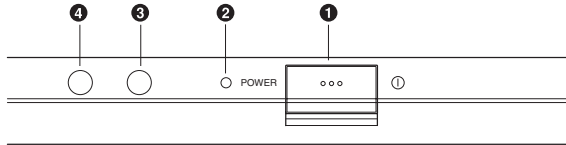

### AV-2156BE

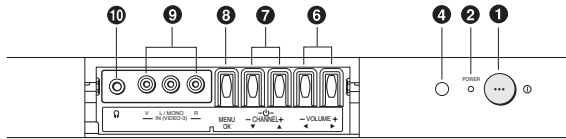

No. Button/terminal	Description	Page
① ① (main power)	Press to turn on or turn off the TV's main power.	-
② POWER lamp	Indicate the TV's status. No colour : TV's main power is being turned off. Red : TV's main power is being turned on. Blink : While the TV is in standby mode, ON TIMER function is in used. While the TV is in turn on mode, OFF TIMER function is in used. Note: When you turn off the power switch while TV is in standby mode, the power lamp will go off in 10 -15 seconds. When you operate the TV, POWER Lamp will be blink.	-
③ ECO sensor		-
④ Remote control sensor		-
⑤ TV/VIDEO	Press to select TV or Video terminal input or exit from menu.	-
⑥ VOLUME +/-	Press to adjust the volume level.	-
⑦ CHANNEL +/-	Press to select the desired channel (Both of RF and Video input.)	-
⑧ MENU/OK	Press to display the menu.	-
⑨ IN (VIDEO-3)	Video and audio input jacks for VIDEO-3 mode.	22
⑩	Headphone jack.	22
⑪	Aerial socket.	7
⑫ OUTPUT	Video and audio output jacks. (The component video signal cannot be output.)	22
⑬ COMPONENT (VIDEO-2) INPUT	Video or component video, and audio input jacks for VIDEO-2 mode. You can select the input signal by setting the "VIDEO-2 SETTING" function (see page 18).	22
⑭ VIDEO-1 INPUT	Video or S-VIDEO, and audio input jacks for VIDEO-1 mode.	7

## How to operate the menus with the TV button

TV button	Work as same as the button on the remote control unit	Note
MENU	MENU/OK button	To display main menu and exit menu after finish setting.
CHANNEL +/-	▼/▲ button	To select menu function.
VOLUME +/-	◀▶ button	To choose a Top menu and adjust the desired menu function.

## Rear of the TV

### AV-2988SE

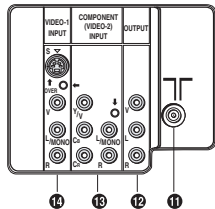

# Setting up your TV

## CAUTION

- Turn off the equipment including the TV before connecting.

### 1 Connecting the aerial cable.

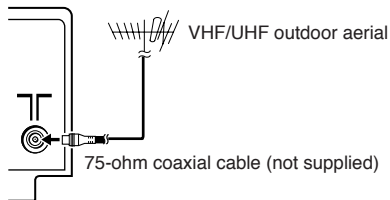

If you connect a VCR, connect the aerial output jack of your VCR and the aerial jack on the TV with aerial cable. Then connect the output jacks of your VCR and the VIDEO-1 input jacks of the TV with the video cable (or S-VIDEO cable if available) and audio cables. For details, see the manual of your VCR.

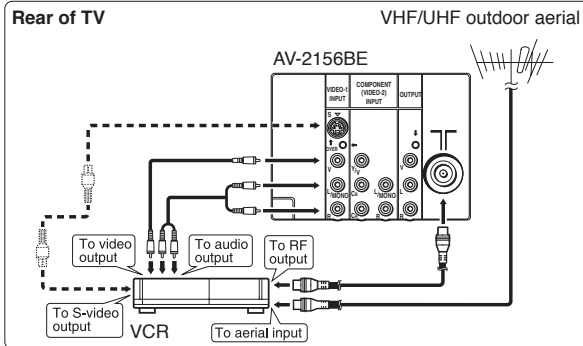

The illustration shown is just a sample. It may not be same as your TV.

### 2 Connecting the main plug to the AC outlet.

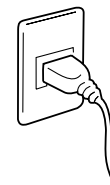

### 3 Inserting batteries into the remote control.

Insert two batteries by following the ⊕ and ⊖ polarities and inserting the ⊖ end first.

#### CAUTION:

Follow the cautions printed on the batteries.

Notes:

- Use AA/R6/UM-3 dry cell batteries.
- If the remote control does not work properly, fit new batteries. The supplied batteries are for testing, not regular use.

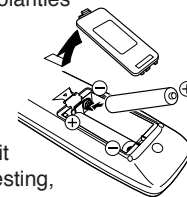

### 4 Turn on the TV by pressing the main power button.

JVC logo appears on the screen.



JVC logo will appear on the screen again at the phase of "SETUP TOUR RESTART?" function. Then the initial setting can be performed according to page 8.

#### Note:

While in the INSTALL menu with the cursor pointing at INSTALL, pressing the blue button will also display the JVC logo.

## Setting up your TV (continued)

### 5 Making the initial settings

Set up your TV by pressing MENU/OK button or waiting for 15 seconds, then operate the TV by following the steps below:



- Press ▲/▼ button to select your desired language.

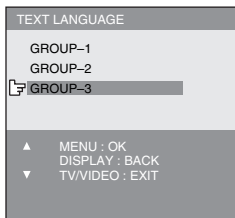

- Press ▲/▼ button to select your desired Teletext language group. For details, see page 13.

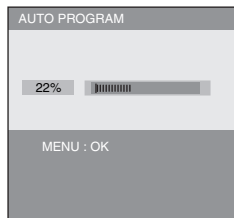

- TV will start searching for the channels.  
  
To stop AUTO PROGRAM, press MENU/OK button.

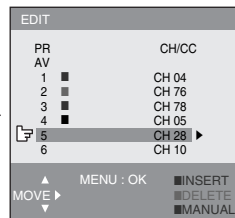

- To complete the initial setting, press the MENU/OK button. To edit the channel list, see page 19.

### When turn on the TV at the next time

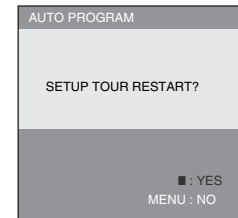

- “SETUP TOUR RESTART?” will be displayed. Press the MENU/OK button to cancel the SETUP TOUR RESTART function. If you want to make initial settings again when the next time you turn on the TV, press the Red button to activate the SETUP TOUR RESTART function.



# Basic setting for picture

## COLOUR SYSTEM

You can select the appropriate colour system when the picture is not clear or no colour appears.

Press the COLOUR SYSTEM button to select a setting.

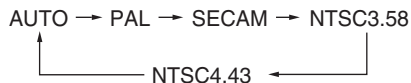

To operate this function with a menu:

\* (MENU) ➔ (INSTALL menu) ➔ (COLOUR SYSTEM)

For the colour system in each country or region, see the table below:

Area	Country or Region	System
Asia, Middle East	Bahrain, Kuwait, Oman, Qatar, United Arab Emirates, Yemen, etc.	PAL
	Indonesia, Malaysia, Singapore, Thailand, India, etc.	PAL
	China, Vietnam, etc.	PAL
	Hong Kong, etc.	PAL
	Islamic Republic of Iran, Lebanon, Saudi Arabia, etc.	SECAM
Europe	Philippines, Taiwan, Myanmar, etc.	NTSC
	Russia, etc.	SECAM
	Czech Republic, Poland, etc.	PAL
	Germany, Holland, Belgium, etc.	PAL
Oceania	UK, etc.	PAL
	Australia, New Zealand, etc.	PAL
Africa	Republic of South Africa, etc.	PAL
	Nigeria, etc.	PAL
	Egypt, Morocco, etc.	SECAM

## PICTURE MODE

You can choose the desired picture setting with one-touch.

Press the PICTURE MODE button to select a setting.

SOFT	Softens contrast and sharpness.
BRIGHT	Heightens contrast and sharpness.
STANDARD	Standard picture setting.
USER	You can change this picture setting as you like. Select USER and adjust following items in the PICTURE SETTING menu. (CONTRAST, BRIGHT, SHARP, COLOUR, TINT)

When you select VIDEO-2 Mode, you cannot adjust SHARP.

When you set DVD THEATER STATUS in DVD MENU to ON, you cannot adjust PICTURE MODE.

To operate this function with a menu:

\* (MENU) ➔ (PICTURE menu) ➔ (PICTURE MODE)

To return the USER setting to default, press the blue button when the PICTURE SETTING menu is displayed.

\* About the basic operations of the menu, please see the “How to operate menus and menus locations” on page 5.

## Basic setting for picture (continued)

### PICTURE SETTING

You can adjust the desired picture setting when selecting USER in PICTURE MODE.

- 1 Select USER in PICTURE MODE under PICTURE menu.

\* (MENU) → (PICTURE menu) → (PICTURE MODE)  
→ (USER)

- 2 Select PICTURE SETTING in PICTURE menu, then adjust the setting.

\* (MENU) → (PICTURE menu) → (PICTURE SETTING)

CONTRAST	◀ : Lower contrast	▶ : Higher contrast
BRIGHT	◀ : Darker	▶ : Brighter
SHARP	◀ : Softer	▶ : Higher
COLOUR	◀ : Lighter	▶ : Deeper
TINT	◀ : Reddish	▶ : Greenish

When you select VIDEO-2 Mode, you cannot adjust SHARP.

### WHITE BALANCE

You can change the white balance of the picture to better match the type of video being viewed.

Select WHITE BALANCE in the PICTURE menu, then choose the desired setting.

\* (MENU) → (PICTURE menu) → (WHITE BALANCE)

NORMAL	Normal white balance.
COOL	Bluish white.
WARM	Reddish white.

When you set DVD THEATER STATUS in DVD MENU to ON, you cannot adjust WHITE BALANCE.

\* About the basic operations of the menu, please see the “How to operate menus and menu locations” on page 5.

# Advanced setting for picture

## AI ECO SENSOR (ECO)/ECO MODE

You can adjust TV screen contrast according to the brightness of your room.

Press the ECO button to select the desired mode.

OFF	Cancel the function.
MODE-1/ECO-1	Mild contrast (recommended.)
MODE-2/ECO-2	Even contrast.
DISPLAY (for AI ECO SENSOR only)	Display the graphic of the function.

To operate this function with a menu:

\* (MENU) → (FEATURES menu)  
→ (AI ECO SENSOR / ECO MODE)

When you set DVD THEATER STATUS in DVD MENU to ON, you cannot adjust AI ECO SENSOR / ECO MODE.

Note : AI ECO SENSOR for M and S series.  
ECO MODE for B series.

## Correcting the Slanting Picture (PICTURE TILT)

You can correct the picture tilt caused by the earth's magnetic force.

1 Select PICTURE TILT in the INSTALL menu, then press MENU/OK button.

\* (MENU) → (INSTALL menu) → (PICTURE TILT)

The following display appears.



2 Press the ▲/▼ buttons until the picture becomes level. Then press the MENU/OK button.

## COMPRESS (16:9)

You can convert a normal picture (4:3 aspect ratio) into a wide picture (16:9 aspect ratio).

Select COMPRESS (16:9) in the FEATURES menu, then choose ON or OFF.

\* (MENU) → (FEATURES menu) → (COMPRESS (16:9))

## BLUE BACK

You can set the TV to automatically change to a blue screen and mute the sound if the signal is weak or absent, or when there is no input from an antenna.

Select BLUE BACK in the INSTALL menu, then choose ON or OFF.

\* (MENU) → (INSTALL menu) → (BLUE BACK)

If you wish to continue viewing the poor picture, off the BLUE BACK function.

\* About the basic operations of the menu, please see the "How to operate menus and menus locations" on page 5.

# Original features for picture

## PIP

You can display a sub picture within the main picture on the screen. Press the PIP operation buttons to display and change the sub picture setting.





PIP Display the sub picture.  
To cancel, press the PIP button again.

### Notes:

- You can hear the sound from the main picture only.
- When main picture and sub picture are the same TV channel.

Press SUB-P +/-	Main picture will be changed TV channel follow as sub picture.
Press  ( Input )	To change sub picture to video mode.

Press CHANNEL +/-	Sub picture will be changed TV channel follow as Main picture.
Press CHANNEL +/-	Until main picture change to video mode.

SUB-P +/-	Select the desired TV channel for sub picture.
 (Input)	Select the input source for the sub picture.
 (Swap)	Swap between the main picture and sub picture.
 (Position)	Change the sub picture position. Each time you press the  (Position) button, the sub picture position will change as follows: lower right → lower left → upper left ↑ upper right ←
 (Freeze)	Freeze the sub picture.

When VIDEO-2 is set to component, you cannot select VIDEO-2 for sub picture. If the main picture input source is VIDEO-2 with component, the PIP function is disabled.

## TELETEXT

You can watch the Teletext broadcast channel with TEXT function.



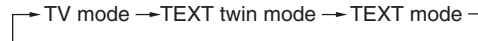









1 Press the TEXT button to select the desired mode as follows:



2 Press the CHANNEL +/- buttons, number buttons or colour buttons to select other Teletext pages.

3 Press TEXT or TV/VIDEO button to return to TV mode.

You can also operate the teletext using the following buttons:

 (Hold)	Hold a teletext page. The  (Hold) icon is displayed at the top left of the screen. To cancel, press  (Hold) button again.
 (Reveal)	Display the hidden text (e.g. answers to a quiz). To cancel, press  (Reveal) button again.
 (Size)	Enlarge the teletext display.
 (Index)	Return to the index page instantly.
 (Cancel)	Watch TV programme while waiting for a teletext page. When the teletext page is found, a page number appears at the upper left of the screen. Press  (Cancel) button to view the teletext page.
 (Sub-page)	Operate the  (Sub-page) function. Sub-page numbers are displayed at the left of the screen. To cancel sub-page function, press  (Sub-page) button again.

## Original features for picture (continued)

---

### TEXT LANGUAGE

You can set the Teletext language group that corresponds to the programmes.

Select TEXT LANGUAGE in the INSTALL menu, then choose the desired language group.

\* (MENU) → (INSTALL menu) → (TEXT LANGUAGE)

---

GROUP-1	English, German, Swedish, Finnish, Danish, Hungarian, Italian, French, Spanish, Portuguese, Turkish
GROUP-2	Polish, German, Estonian, Slovenian, Czech, Slovakian, Rumanian
GROUP-3	Polish, German, Estonian, Lettish, Russian, Ukrainian

---

Depending on the broadcast, the language set may not display properly. For details, refer to page 8.

\* About the basic operations of the menu, please see the “How to operate menus and menus locations” on page 5.

# Basic setting for sound

## SOUND SYSTEM

You can select an appropriate sound system when abnormal sound occurs even when the picture appears normally. Press the SOUND SYSTEM button to select a setting.

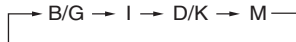

This function is not available in video mode.  
For the sound system in each country or region, see the table below:

Area	Country or Region	System
Asia, Middle East	Bahrain, Kuwait, Oman, Qatar, United Arab Emirates, Yemen, etc. Indonesia, Malaysia, Singapore, Thailand, India, etc.	B/G
	China, Vietnam, etc.	D/K
	Hong Kong, etc.	I
	Islamic Republic of Iran, Lebanon, Saudi Arabia, etc.	B/G
	Philippines, Taiwan, Myanmar, etc.	M
Europe	Russia, etc.	D/K
	Czech Republic, Poland, etc.	D/K
	Germany, Holland, Belgium, etc.	B/G
	UK, etc.	I
Oceania	Australia, New Zealand, etc.	B/G
Africa	Republic of South Africa, etc.	I
	Nigeria, etc.	B/G
	Egypt, Morocco, etc.	B/G

## SOUND MODE

You can choose the desired sound setting.  
Select the SOUND MODE in SOUND menu, then choose the setting.

\* (MENU) → (SOUND menu) → (SOUND MODE)

---

USER You can change this sound setting as you like.  
Select USER and adjust the frequencies in EQUALIZER (100, 300, 1K, 3K, 8K Hz).  
For details, see "EQUALIZER" on page 15.

---

SOUND TURBO Emphasize on low and high frequency levels.

---

THEATER Emphasize on movie sound.

---

MUSIC Emphasize on music effect.

---

NEWS Emphasize on vocal sound.

When you select VIDEO-2, you cannot adjust SOUND MODE function. You can adjust it in DVD Menu.

When SOUND MODE is set to SOUND TURBO, EQUALIZER, CINEMA SURROUND and MaxxBass functions are not available.

## BALANCE

You can adjust the volume balance between the left and right speakers.

Select BALANCE in SOUND menu, then adjust the setting.

\* (MENU) → (SOUND menu) → (BALANCE)

\* About the basic operations of the menu, please see the "How to operate menus and menu locations" on page 5.

# Advanced setting for sound

## CINEMA SURROUND

You can enjoy an enhanced sound for wider audience.  
Press the CINEMA SURROUND button to select a setting.

OFF	Cancel the function.
ON	Listen to sound with wider audience effect.



This function is not available when SOUND MODE is set to SOUND TURBO.

To operate this function with a menu:

\* (MENU) → (SOUND menu) → (CINEMA SURROUND)

## STEREO / I-II ( I/II )

You can enjoy the stereo and bilingual broadcasted programmes.  
Press the  I/II button to select the desired mode.

	Select stereo sound.
	Select monaural sound.
<b>I</b>	Select bilingual I (sub I).
<b>II</b>	Select bilingual II (sub II).

This function is not available in video mode.

To operate this function with a menu:

\* (MENU) → (SOUND menu) → (STEREO / I-II)

## MaxxBass

You can enjoy an enhanced bass sound which cannot be reproduced by normal speakers.

Select MaxxBass in SOUND menu, then choose the desired setting.

\* (MENU) → (SOUND menu) → (MaxxBass)

OFF	MaxxBass is turned off.
HIGH	MaxxBass effect is high.
LOW	MaxxBass effect is low.

This function is not available when SOUND MODE is set to SOUND TURBO.

“MaxxBass” is a registered trademark of Waves Audio Ltd. in the USA, Japan and other countries.

## EQUALIZER

You can adjust the sound level of each frequencies when selecting USER mode in SOUND MODE.

1 Select USER in SOUND MODE under SOUND menu.

\* (MENU) → (SOUND menu) → (SOUND MODE) → (USER)

2 Select EQUALIZER in SOUND menu.

\* (MENU) → (SOUND menu) → (EQUALIZER)

The following display appears.

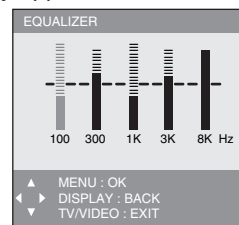

3 Select and adjust the desired frequencies.

4 Press the MENU/OK button to exit the menu.

Adjust high frequency will affect higher pitch sound and vice versa.  
When you select VIDEO-2, you cannot adjust EQUALIZER.

## AI VOLUME

You can adjust the volume of all the channels and video inputs to the same level automatically depends on the strength of signal of the sources.

Select AI VOLUME in SOUND menu, then choose ON or OFF.

\* (MENU) → (SOUND menu) → (AI VOLUME)

\* About the basic operations of the menu, please see the “How to operate menus and menus locations” on page 5.

# DVD Menu

## AUTO SIGNAL DETECT

When the DVD input signal is detected, the input mode will be changed to VIDEO-2 automatically. And when the DVD input signal is not detected, the input mode will be changed to RF previous input mode.

Select AUTO SIGNAL DETECT in DVD MENU under FEATURES menu then choose ON or OFF (Factory setting is ON).

\* (MENU) → (FEATURES menu) → (DVD MENU)  
→ (AUTO SIGNAL DETECT)

Press the "POWER ON" button on the DVD players or VCRs (follow by the "PLAY" button for VCRs) so that the signal can be detected.

## DVD PICTURE MODE

You can enhance the picture quality of the DVD or VIDEO-2.

Select DVD PICTURE MODE in DVD MENU under FEATURES menu, then choose the desired setting.

\* (MENU) → (FEATURES menu) → (DVD MENU)  
→ (DVD PICTURE MODE)

OFF	Cancel the function.
CLEAR-1	Select when the disc is with lots of noise (To soften the picture).
CLEAR-2	Select when the disc is with less noise (To sharpen the picture).

## DVD THEATER STATUS

You can enjoy an enhanced picture quality for movie playback in a dark room, like watching a movie in the theater.

Select DVD THEATER STATUS in DVD MENU under FEATURES menu, then choose ON or OFF.

\* (MENU) → (FEATURES menu) → (DVD MENU)  
→ (DVD THEATER STATUS)

ON	Enjoy movie playback with suitable colour temperature, sharp subtitles and improved gradation for black, like in a theater.
OFF	Cancel the function.

When you set DVD THEATER STATUS to ON, PICTURE MODE, WHITE BALANCE and AI ECO SENSOR / ECO MODE functions are not available.

## DVD SOUND MODE

You can choose different sound setting for viewing different types of DVD content.

Select DVD SOUND MODE in DVD MENU under FEATURES menu, then choose the desired setting.

\* (MENU) → (FEATURES menu) → (DVD MENU)  
→ (DVD SOUND MODE)

MUSIC	Select when watching a music concert.
USER	Select if you want to adjust the sound setting to your preference.
DRAMA	Select when watching a drama movie.
THEATER	Select when watching an action movie.

\* About the basic operations of the menu, please see the "How to operate menus and menu locations" on page 5.



# Customized setting

## VNR

You can reduce the picture noise.

Select VNR in PICTURE menu, then choose a setting of VNR function.

\* (MENU) → (PICTURE menu) → (VNR)

OFF	VNR is turned off.
AUTO	Effect of VNR is automatically controlled.
MIN	Effect of VNR becomes minimum level.
MAX	Effect of VNR becomes maximum level.

If you select MAX, the picture becomes softer even if the original picture is sharp.

When you select VIDEO-2, you cannot adjust VNR function.

## LANGUAGE

You can choose your desired on screen display language.

Select LANGUAGE in the INSTALL menu, then choose a language.

\* (MENU) → (INSTALL menu) → (LANGUAGE)

## CHILD LOCK

You can disable the front control buttons of the TV.

Select CHILD LOCK in the FEATURES menu, then choose ON or OFF.

\* (MENU) → (FEATURES menu) → (CHILD LOCK)

## ON TIMER

You can set the TV to turn on automatically from standby mode at a set channel and time.

1 Select ON TIMER in the FEATURE menu.

\* (MENU) → (FEATURES menu)  
→ (ON TIMER)

The following display appears.

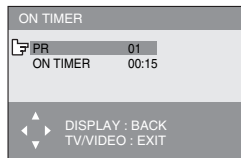

2 Choose the PR (channel) by pressing the ◀/▶ button.

External input, AV position and any un-preset channel cannot be chosen for PR.

3 Set the ON TIMER to your desired period of time by pressing the ◀/▶ button. ON TIMER starts. You can set the period of time to a maximum of 12 hours in 15-minute intervals.

To off the ON TIMER, set the ON TIMER to OFF.

Note : If TV is not in standby mode when ON TIMER is reach the setting time, this case is not available.

## OFF TIMER

You can set the TV to turn off automatically to standby mode after a set time.

Press the OFF TIMER button to select a desired period of time.

You can set the period of time to a maximum of 120 minutes in 10 minute intervals.

To operate this function with a menu:

\* (MENU) → (FEATURES menu) → (OFF TIMER)

When the remaining elapse time is one minute, "GOOD NIGHT!" appears on the screen.

You can display the OFF TIMER menu again to confirm or change the remaining time.

\* About the basic operations of the menu, please see the "How to operate menus and menus locations" on page 5.

## Customized setting (continued)

### VIDEO-2 SETTING

You can set the VIDEO-2 SETTING according to the video signal output from external devices connected to the VIDEO-2 terminal. Select VIDEO-2 SETTING in INSTALL menu, then choose a setting (Factory setting is COMPONENT).

\* (MENU) → (INSTALL menu) → (VIDEO-2 SETTING)

VIDEO	If a normal video signal (composite video signal) is input.
COMPONENT	If a component video signal (Y/C <sub>B</sub> /C <sub>R</sub> ) is input.

You must choose a setting according to the signal that you input to VIDEO-2. (If you input the VIDEO Signal or VCR Signal to VIDEO-2, you must set VIDEO-2 SETTING to VIDEO.)

For connecting methods, see “Additional Preparation” on page 22.

### BEEP

You can use the BEEP function to alert you during DVD AUTO SIGNAL DETECT, AI ECO SENSOR Detect, Stereo Detect, ON TIMER/OFF TIMER operations and when some buttons on the remote control are pressed.

Select BEEP in the INSTALL menu, then choose ON or OFF.

\* (MENU) → (INSTALL menu) → (BEEP)

When the volume is level 0, then BEEP function is not available.

### DISPLAY

You can display the programme number, video terminal number and PR list on the screen.

Press the DISPLAY button to select the desired mode:

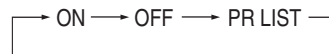

Choose a TV channel or a VIDEO terminal.

- 1 Press the DISPLAY button to display the PR LIST.
- 2 Select a programme number or video terminal by pressing the ▲/▼ button to move up/down on the programme number or press the ◀▶ button to skip for each 7 programme numbers, then press MENU/OK button.

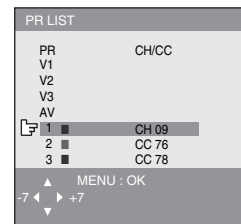

\* About the basic operations of the menu, please see the “How to operate menus and menu locations” on page 5.

# TV channel presetting

## To register the TV channels automatically (AUTO PROGRAM)

You can register the TV channels into the TV's channel list automatically.

- 1 Display the INSTALL menu.

\* (MENU) ➔ (INSTALL menu)

- 2 Choose AUTO PROGRAM, then press the MENU/OK button. AUTO PROGRAM function starts, and the channels received are registered in the channel list (PR LIST) automatically.

- 3 The EDIT menu appears.

To edit the channel list	Proceed to Step 3 of "To edit the channel list (PR LIST)" on page 20.
If a channel is not registered	Proceed to Step 3 of "To register the TV channels manually" on this page.
To exit the menu	Press the MENU/OK button.

## To register the TV channels manually (MANUAL in the EDIT menu)

You can register the TV channels into the TV's channel list manually.

- 1 Display the INSTALL menu.

\* (MENU) ➔ (INSTALL menu)

- 2 Choose EDIT/MANUAL, then press the MENU/OK button. EDIT menu appears.

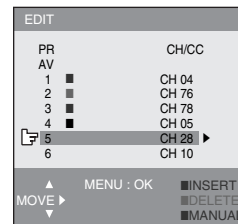

- 3 Choose the channel which you want to register.
- 4 Press the blue button to activate the MANUAL function. The sound system of the channel appears at the right of the CH/CC number.
- 5 Press the ► button to choose an appropriate sound system. For details, see "SOUND SYSTEM" on page 14.
- 6 Press the green or red button to search for the TV channel. Searching stops when a channel is found and displayed.
- 7 Repeat step 5 until your desired TV channel appears.

If the reception is poor	Press the blue or yellow button to fine tune the TV channel.
If noisy sound is heard	Press the ► button to choose an appropriate sound system.

- 8 Press the MENU/OK button to exit the menu.

\* About the basic operations of the menu, please see the "How to operate menus and menu locations" on page 5.

## TV channel presetting (continued)

### To edit the channel list (PR LIST) (MOVE and DELETE in the EDIT menu)

You can edit the TV channel list as you like.

Note: After this operation, other channel's PR numbers will be changed.

- 1 Display the INSTALL menu.

\* (MENU) ➔ (INSTALL menu)

- 2 Choose EDIT/MANUAL, then press the MENU/OK button.  
EDIT menu appears.

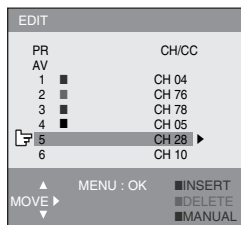

- 3 Choose the channel which you want to change its PR number, or delete.

- 4 Do the following action:

---

To change the PR number (MOVE)	Press the ▶ button. Then move it to the new PR number you want to use for the channel by pressing the ▲/▼ button. Finally press the ◀ button.
--------------------------------	---

---

To delete the channel (DELETE)	Press the yellow button.
--------------------------------	--------------------------

---

- 5 Press the MENU/OK button to exit the menu.

### To add in the new channel (INSERT in the EDIT menu)

You can add in new channels in the TV channel list as you like.

You need to find the “CH/CC” number for the TV channel. Find the “CH/CC” number corresponding to the channel number of the TV channel from “CH/CC number list” on page 21.

- 1 Display the INSTALL menu.

\* (MENU) ➔ (INSTALL menu)

- 2 Choose EDIT/MANUAL, then press the MENU/OK button.  
EDIT menu appears.

- 3 Choose the PR number for which you will register a new TV channel. When you add a new TV channel of NTSC-M system, press the SOUND SYSTEM button to change the sound system to M. Then proceed to the next step.

- 4 Press the green button, then press ▶ button to choose “CC” or “CH”.

- 5 Press the number button to enter the CH/CC number for the TV channel you wish to add.

The TV starts to search the TV channel, and the picture of the TV channel appears. If the TV finds no TV channel, a noisy picture appears.

When a TV channel has already been registered in PR99, using the INSERT function deletes that TV channel.

\* About the basic operations of the menu, please see the “How to operate menus and menus locations” on page 5.

## TV channel presetting (continued)

### CH/CC number

When you want to use the INSERT function on page 20, find the CH/CC number corresponding to the channel number of the TV channel from this table.

Channel No.	Country
US	United States, Philippines, etc..
CCIR	Middle East, Southeast Asia, etc..
OIRT	Eastern Europe, Russia, Vietnam, etc..
AUSTRALIA	Australia, etc..

### Channel

CH	US	CCIR	OIRT	AUSTRALIA
CH 02	US-2	E2	R1	AU-0
CH 03	US-3	E3		AU-1
CH 04	US-4	E4	R2	AU-2
CH 05	US-5	E5	R6	AU-6
CH 06	US-6	E6	R7	AU-7
CH 07	US-7	E7	R8	AU-8
CH 08	US-8	E8	R9	AU-9
CH 09	US-9	E9		
CH 10	US-10	E10	R10	AU-10
CH 11	US-11	E11	R11	AU-11
CH 12	US-12	E12	R12	
CH 13	US-13			
CH 14	US-14, W+29			
CH 15	US-15, W+30			
CH 16	US-16, W+31			
CH 17	US-17, W+32			
CH 18	US-18, W+33			
CH 19	US-19, W+34			
CH 20	US-20, W+35			
CH 21	US-21, W+36	E21		
CH 22	US-22, W+37	E22		
CH 23	US-23, W+38	E23		
CH 24	US-24, W+39	E24		
CH 25	US-25, W+40	E25		
CH 26	US-26, W+41	E26		
CH 27	US-27, W+42	E27		
CH 28	US-28, W+43	E28		AU-28
CH 29	US-29, W+44	E29		AU-29
CH 30	US-30, W+45	E30		AU-30
CH 31	US-31, W+46	E31		AU-31/AU-32
CH 32	US-32, W+47	E32		AU-33

CH	US	CCIR	OIRT	AUSTRALIA
CH 33	US-33, W+48	E33		AU-34
CH 34	US-34, W+49	E34		AU-35
CH 35	US-35, W+50	E35		AU-36
CH 36	US-36, W+51	E36		AU-37
CH 37	US-37, W+52	E37		AU-38
CH 38	US-38, W+53	E38		AU-39/AU-40
CH 39	US-39, W+54	E39		AU-41
CH 40	US-40, W+55	E40		AU-42
CH 41	US-41, W+56	E41		AU-43
CH 42	US-42, W+57	E42		AU-44
CH 43	US-43, W+58	E43		AU-45
CH 44	US-44, W+59	E44		AU-46
CH 45	US-45, W+60	E45		AU-47/AU-48
CH 46	US-46, W+61	E46		AU-49
CH 47	US-47, W+62	E47		AU-50
CH 48	US-48, W+63	E48		AU-51
CH 49	US-49, W+64	E49		AU-52
CH 50	US-50, W+65	E50		AU-53
CH 51	US-51, W+66	E51		AU-54
CH 52	US-52, W+67	E52		AU-55/AU-56
CH 53	US-53, W+68	E53		AU-57
CH 54	US-54, W+69	E54		AU-58
CH 55	US-55, W+70	E55		AU-59
CH 56	US-56, W+71	E56		AU-60
CH 57	US-57, W+72	E57		AU-61
CH 58	US-58, W+73	E58		AU-62
CH 59	US-59, W+74	E59		AU-63/AU-64
CH 60	US-60, W+75	E60		AU-65
CH 61	US-61, W+76	E61		AU-66
CH 62	US-62, W+77	E62		AU-67
CH 63	US-63, W+78	E63		AU-68
CH 64	US-64, W+79	E64		AU-69
CH 65	US-65, W+80	E65		
CH 66	US-66, W+81	E66		
CH 67	US-67, W+82	E67		
CH 68	US-68, W+83	E68		
CH 69	US-69, W+84	E69		

CC	US	CCIR	OIRT	AUSTRALIA
CC 01		S-1		AU-5
CC 02		S-2		
CC 03		S-3		
CC 04		S-4		
CC 05		S-5		
CC 06		S-6		AU-5A
CC 07		S-7		
CC 08		S-8		
CC 09		S-9		
CC 10		S-10		
CC 11		S-11		
CC 12		S-12		
CC 13		S-13		
CC 14	A	S-14		
CC 15	B	S-15		
CC 16	C	S-16		
CC 17	D	S-17		

CC	US	CCIR	OIRT	AUSTRALIA
CC 18	E	S-18		
CC 19	F	S-19		
CC 20	G	S-20		
CC 21	H	S-21		
CC 22	I	S-22		
CC 23	J	S-23		
CC 24	K	S-24		
CC 25	L	S-25		
CC 26	M	S-26		
CC 27	N	S-27		
CC 28	O	S-28		
CC 29	P	S-29		
CC 30	Q	S-30		
CC 31	R	S-31		
CC 32	S	S-32		
CC 33	T	S-33		
CC 34	U	S-34		
CC 35	V	S-35		
CC 36	W	S-36		
CC 37	W+1	S-37		
CC 38	W+2	S-38		
CC 39	W+3	S-39		
CC 40	W+4	S-40		
CC 41	W+5	S-41		
CC 42	W+6			
CC 43	W+7			
CC 44	W+8			
CC 45	W+9			
CC 46	W+10			
CC 47	W+11			
CC 48	W+12			
CC 49	W+13			
CC 50	W+14			
CC 51	W+15			
CC 52	W+16			
CC 53	W+17			
CC 54	W+18			
CC 55	W+19			
CC 56	W+20			
CC 57	W+21			
CC 58	W+22			
CC 59	W+23			
CC 60	W+24			
CC 61	W+25			
CC 62	W+26			
CC 63	W+27			
CC 64	W+28			
CC 75		X		
CC 76		Y	R3	
CC 77		Z	R4	AU-3
CC 78		Z+1	R5	
CC 79		Z+2		AU-4
CC 95	A-5			
CC 96	A-4			
CC 97	A-3			
CC 98	A-2			
CC 99	A-1			

# Additional preparation

The illustrations shown in this section are for AV-2156BE and AV-2988SE, which are used for explanation purpose. Your TV may not look exactly the same as illustrated.

## Before connecting

- Read the manuals provided with the devices for the proper connection.
- Turn off all the devices including the TV.
- Note that connecting cables are not supplied.

## Connecting to front video input terminals

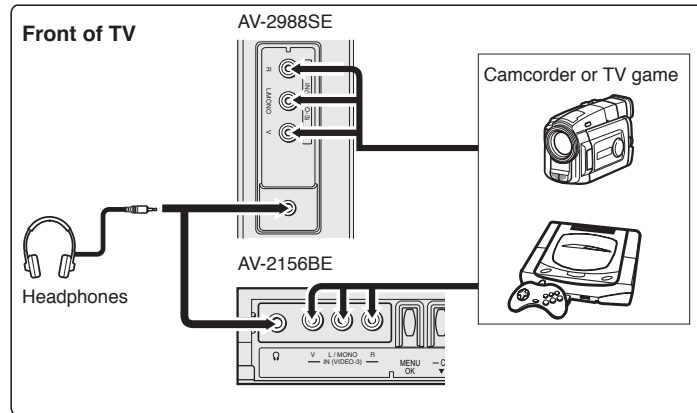

## Connecting to rear component/video input terminals and output terminals

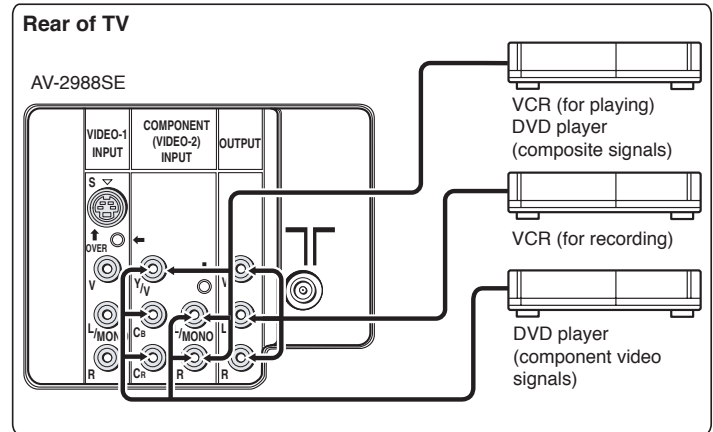

When connecting to COMPONENT (VIDEO-2) input, depending on the connection, choose the appropriate video input using the menu (see "VIDEO-2 SETTING" on page 18)

# Troubleshooting

If a problem occurs when you are using the TV, check the below troubleshooting guide before calling for repair.

• No picture, no sound	• Deactivate the BLUE BACK function if it is turned on. • Choose the appropriate sound system. Refer to "SOUND SYSTEM" on page 14.
• Snowy picture	• Check the aerial cable and its connection with the TV.
• Stripes appear on the picture	• Interference occurs caused by other devices such as an amplifier, personal computer, or a hair drier. Move such devices away from your TV.
• Double-pictures (ghosting) occur	• Interference occurs caused by signal reflecting from mountains or building. Try to adjust the aerial's direction or use a better directionality antenna.
• Poor picture	• Choose the appropriate colour system. Refer to "COLOUR SYSTEM" on page 9. • Adjust the COLOUR or BRIGHT setting. Refer to "PICTURE SETTING" on page 10.
• White and bright still image look as if it were coloured	• Inevitable phenomenon due to the nature of the picture tube. This is not a malfunction.
• Top of the image from software products or video tape is distorted	• This is due to the condition of the video signal whereby the image was not recorded properly. This is not a malfunction.
• Poor sound	• Adjust the sound frequency properly. Refer to "EQUALIZER" on page 15.
• Stereo or bilingual sound is unclear	• TV channel reception is poor. Change the stereo/bilingual mode to mono sound (see page 15).
• Cannot operate the remote control	• The batteries may be exhausted. Replace with new batteries (see page 7). • Ensure that you are operating the remote control at less than seven meters from the front of your TV.
• Cannot operate the menus	• Press TV/VIDEO button to return to TV mode and try operating the menus.
• Cannot operate the front control buttons	• Deactivate the CHILD LOCK function if it is turned on (see page 17).

• Colour patches appear at the corner of the screen	• This may due to the magnetized device such as a speaker near to your TV. Keep the device apart from your TV. Alternately, you can also use the magnetic-shielded speaker.
• Picture is tilted	• This may due to the earth magnetism. Refer to "PICTURE TILT" on page 11 to correct the tilt.
• Image takes a short period to be displayed	• Image required time to stabilize before display. This is not a malfunction.
• TV may emit crackling sound	• This is due to a sudden change in temperature and it is not a malfunction. If the crackling sound is too frequent, request your service technician for inspection.
• Feel a slight electric shock when touching the TV screen	• This is due to the static electricity of the picture tube and it will not harm the human body. This is not a malfunction.
• The Auto Signal Detect function does not work	• Please check that the AUTO SIGNAL DETECT function is on or off. • Turn the VCR or DVD player off, wait a while, then turn it on again. • Inspect the video cable connection on VIDEO-2 that they are connected properly.
• Suddenly, a channel or input was changed to VIDEO-2 inputs.	• Some VCRs and DVD players can trigger Auto Signal Detect even after you choose a different input. • Please turn off the AUTO SIGNAL DETECT function.
• "PLEASE DISCONNECT VIDEO-1 CABLE!" appears on the screen.	• Please disconnect either S-VIDEO cable or video input cable from Video-1 input.

# Specifications

---

## TV RF systems

B, G, I, D, K, M

## Colour systems

PAL, SECAM, NTSC 3.58 MHz, NTSC 4.43 MHz

## Receiving channels

VHF low channel (VL), VHF high channel (VH), UHF channel (U)  
Receives cable channels in mid band, super band and hyper band.

## Power requirements

For AV-25, AV-29 series: AC 220 to 240 V, 50 Hz / 60 Hz

For AV-21 series: AC 110 to 240 V, 50 Hz / 60 Hz

## External input / output

VIDEO-1: S-video input, VIDEO input, AUDIO L/R input

VIDEO-2/COMPONENT: VIDEO input, AUDIO L/R input, COMPONENT VIDEO (Y/C<sub>B</sub>/C<sub>R</sub>) input

VIDEO-3: VIDEO input, AUDIO L/R input

OUTPUT: VIDEO output, AUDIO L/R output

Headphone jack: Stereo mini jack (3.5 mm diameter)

## \*\*Sound-multiplex systems

A2 (B/G) or NICAM (B/G, I, D/K)

## \*\*Teletext system

FLOF (Fastext), WST (World Standard Text)

## \*\*Language displayed by teletext

Please see the table in the description "TEXT LANGUAGE" on page 13.

---

\*\*Depends on the models, STEREO/II function for the Sound-multiplex systems or Teletext function may not be available.

Please confirm with the chart on page 3.

***Design and specifications subject to change without notice.***

# JVC





## COLOUR TELEVISION

**AV-29BS26**

**AV-29BX16**

**AV-29MS26**

**AV-29MX16**

**AV-29MX56**

**AV-29MX76**

**AV-29SS26**

**AV-29SX56**

**AV-29SX76**

**AV-25MS26**

**AV-25MX16**

**AV-25MX56**

**AV-25MX76**

**AV-21BS26**

**AV-21BX16**

**AV-21BX16B**

**AV-21MS26**

**AV-21MX16**

**AV-21MX56**

**AV-21MX76**

EQUALIZER • CINEMA SURROUND • COMPONENT INPUT

### Contents

Knowing your TV's features .....	3
Remote control buttons and basic functions .....	4
TV buttons and functions.....	6
Setting up your TV.....	7
Basic setting for picture .....	9
Advanced setting for picture.....	11
Original features for picture .....	12
Basic setting for sound .....	14
Advanced setting for sound.....	15
DVD Menu .....	16
Customized setting .....	17
TV channel presetting .....	19
Additional preparation .....	22
Troubleshooting.....	23
Specifications .....	Back cover

## INSTRUCTIONS

Thank you for buying this JVC colour television.  
To make sure you understand how to use your new TV, please read this manual thoroughly before you begin.

**WARNING: TO PREVENT FIRE OR SHOCK HAZARD, DO NOT EXPOSE THIS APPLIANCE TO RAIN OR MOISTURE.**

**CAUTION: TO ENSURE PERSONAL SAFETY, OBSERVE THE FOLLOWING RULES REGARDING THE USE OF THIS TV.**

- 1 Operate only from the power source indicated on the rear of the TV.
- 2 Avoid damaging the power cord and mains plug. When unplugging the TV, grasp the mains plug. Do not pull on the power cord.
- 3 Never block or cover the ventilation openings.  
Never install the TV where good ventilation is unattainable.  
When installing this TV, leave spaces for ventilation around the TV of more than the minimum distances as shown.

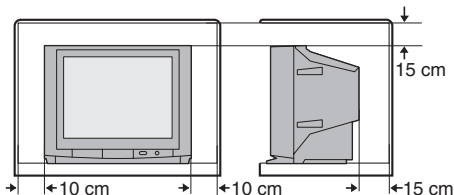

- 4 Do not allow objects or liquid into the cabinet openings.
- 5 In the event of a fault, unplug the unit and call a service technician.  
Do not attempt to repair it yourself or remove the rear cover.
- 6 The surface of the TV screen is easily damaged. Be very careful with it when handling the TV. Should the TV screen become soiled, wipe it with a soft dry cloth. Never rub it forcefully. Never use any cleaner or detergent on it.

- 7 This TV can be turned on/off power by connecting/disconnecting the AC plug into AC outlet. While this TV is being installed, enough space should be reserved for connection/disconnecting the AC plug into AC outlet by hand.
- 8 The apparatus shall not be exposed to dripping or splashing and that no objects filled with liquids, such as vases, shall be placed on the apparatus.

**WARNING: <AV-21M, AV-25M, AV-29M, AV-21B, AV-29B Series>  
YOU CAN DETACH THE PROTECT SHEET ON THE TOP AND BOTTOM OF FRONT FRAME IF YOU NEEDED.  
THE FRONT BUTTON DOOR OF THE TV SHOULD BE PULLED OUT FROM ITS BOTTOM. DO NOT PRESS THE UPPER PART, OR YOUR FINGER MAY BE PINCHED.**

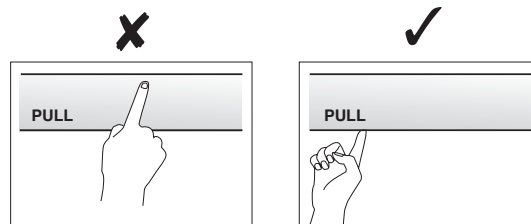

# Knowing your TV's features

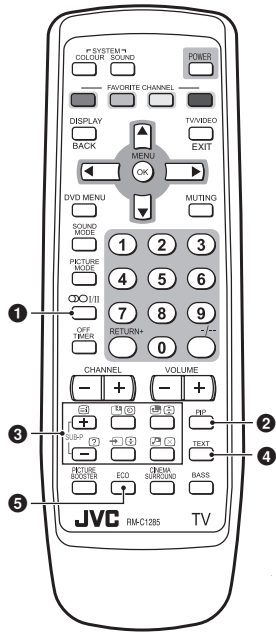

## Main features

<b>DVD MENU</b>	Just connect DVD player to the television. The television will detect DVD signal and display picture on the screen automatically and you can adjust pictures and sound while you are watching DVD as your desire. When disconnect DVD player, the television will display the previous channel.
<b>MaxxBass</b>	MaxxBass enhances bass sound that cannot be reproduced by normal speakers to be heard by our ears.
<b>PIP (Picture In Picture)</b>	You can view two screens ( Main picture and Sub picture ) at the same time.
<b>TELETEXT</b>	You can view teletext programmes which are broadcasted by some TV channels. Teletext programme is an information in text form.
<b>FAVORITE CH (Channel)</b>	You can register up to four favorite channels for quick recall with one press.
<b>A2/NICAM (STEREO / I-II)</b>	You can listen the stereo sound or bilingual sound from TV programme broadcasting by A2 or NICAM Sound-multiplex system.
<b>AI ECO SENSOR</b>	TV detects the brightness of your room and automatically adjust the picture brightness to a suitable level for a better eyecare.
<b>ECO MODE</b>	You can adjust TV screen contrast according to the brightness of your room to suitable level for a better eyecare.
<b>AI VOLUME</b>	TV adjusts the volume automatically to the same level for all TV channels to avoid sudden change of the volume when selecting different TV channels or selecting Video Mode.
<b>TINT</b>	You can adjust TINT setting for all colour systems, including PAL.

## Confirm your TV's functions

Some functions written in this instruction manual may not be available for your TV.

Please see the chart below and check the functions that are equipped for your TV's model number.

The model number is indicated at the rear of your TV. When you press a button concerned to a function that is not available for your TV, it does not work and the logo "Ø" appears on the screen.

NO.	Function	Model No.																				
		AV-29BS26	AV-29BX16	AV-29MX16	AV-29MS26	AV-29SS26	AV-29MX56	AV-29SX56	AV-29MX76	AV-29SX76	AV-25MS26	AV-25MX16	AV-25MX56	AV-25MX76	AV-21BS26	AV-21BX16	AV-21BX16B	AV-21MS26	AV-21MX16	AV-21MX56	AV-21MX76	
1	OO I/II (STEREO/I-II)	Ø	—	—	Ø	—	—	—	Ø	—	—	—	—	Ø	—	—	—	—	—	—	—	—
2 3	PIP control buttons (Green label)	—	—	—	—	—	—	—	Ø	Ø	—	—	Ø	Ø	—	—	—	—	—	—	Ø	Ø
4 3	TELETEXT control buttons (Black label)	Ø	—	—	Ø	—	—	—	Ø	Ø	—	—	—	—	—	—	—	—	—	—	—	—
—	PICTURE TILT	Ø	Ø	Ø	Ø	Ø	Ø	Ø	Ø	Ø	—	—	—	—	—	—	—	—	—	—	—	—
—	MaxxBass	—	—	Ø	Ø	Ø	Ø	Ø	Ø	Ø	Ø	Ø	Ø	—	—	—	—	—	—	—	—	—
6	AI ECO SENSOR	—	—	Ø	Ø	Ø	Ø	Ø	Ø	Ø	Ø	Ø	Ø	—	—	—	—	—	—	—	—	—
5	ECO MODE	Ø	Ø	—	—	—	—	—	—	—	—	—	—	Ø	Ø	—	—	—	—	—	—	—

# Remote control buttons and basic functions

No.	Press	To
①	POWER	Turn on or off the TV from standby mode.
②	MENU/OK	Display menu and confirm selected function.
③	▲ / ▼ / ◀ / ▶	Select and adjust menu function.
④	CHANNEL +/-	Select the desired channel number.
⑤	VOLUME +/-	Adjust the volume level.
⑥	TV/VIDEO EXIT	Select TV or video terminal input. On the other hand, you can use this button to EXIT from the menu.
⑦	MUTING	Turn off the volume. Press this button again to resume the volume.
⑧	DISPLAY /BACK	Display the programme number or video terminal number, stereo/bilingual broadcast system and PR list (channel list) on the screen. You can select the channel using the PR list. 1 Press the DISPLAY button once to display the PR list. 2 Press ▲ / ▼ / ◀ / ▶ buttons to choose a channel, then press the MENU/OK button. You can confirm the favorite channels in the PR list. The channels set to favorite channels are indicated with coloured mark.  On the other hand, you can use this button to return to the previous menu.
⑨	0~9, -/--	Select the programme number. For two digits programme number, press -/--, then press the number button.
⑩	RETURN+	a) Return to the frequently view channel with one touch. 1 Choose the channel you want to register. 2 Press and hold RETURN+ button until "RETURN PLUS PROGRAMMED!" appears. To cancel, press and hold RETURN+ button until "RETURN PLUS CANCELED!" appears. b) Return to the previously viewed channel, if you have not set or have cancelled the Return channel as above.
⑪	FAVORITE CHANNEL (colour buttons: red, green, yellow, blue)	Register and recall 4 favorite channels. 1. Choose the TV channel you want to register then press and hold a colour button until "PROGRAMMED! ■" appears. 2. To register other favorite channels, repeat step 1. To recall the favorite channel, press the corresponding colour button. When the TV is in Text function or MENU mode, the favorite channel function is not available. When the TV is in PIP function, the favorite channel function cannot register but can recall the favorite channel.

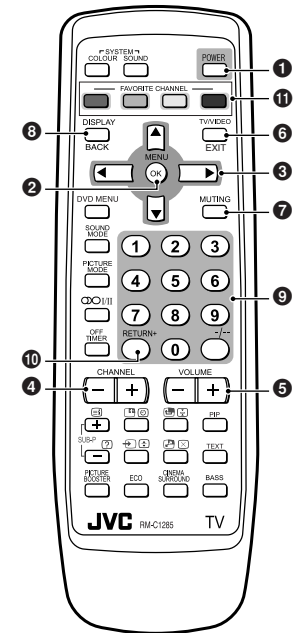

## Remote control buttons and basic functions (continued)

### How to operate menus and menu locations

To	Operation	Note
Display the MENU	Press the MENU/OK button ②. PICTURE MENU is displayed on first press.	To exit the MENU, press the DISPLAY/BACK button ③ or choose EXIT menu or TV/VIDEO/EXIT button ⑥.
Choose a Top menu	Press ◀/▶ buttons ③ to choose a menu title when the cursor is pointing at MENU.	—
Choose a 2nd menu	Press ▲/▼ buttons ③ to choose a 2nd menu title.	Press ▼ button ③ to display the next functions.
Display the 3rd menu	Press ▲/▼ buttons ③ to choose a 2nd menu title. Then press MENU/OK button ②.	
Return to the previous menu	Press the DISPLAY/BACK button ③.	—
Choose the setting of a function	Press ▲/▼ buttons ③ to choose a function. Then press the ◀/▶ buttons ③ to change the setting.	Press the TV/VIDEO/EXIT button ⑥ to exit from the menu.
Adjust the effect level of a function	Press ▲/▼ buttons ③ to choose a function. Then press the ◀/▶ buttons ③ to adjust the effect level.	
Display the sub menu of a function.	Press the ▲/▼ buttons ③ to choose a function. Then press MENU/OK button ② to display the sub menu.	—

The following chart shows locations of functions in menus. In this manual, location of a function is described as follows:

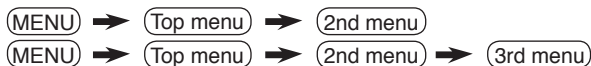

Note: Some functions have the 4th menus as the sub-menus.

	Top menu	2nd menu	Location	3rd menu	Location	
MENU	PICTURE	PICTURE MODE	P.9	—	—	
		PICTURE SETTING	P.10	CONTRAST	P.10	
				BRIGHT	P.10	
				SHARP	P.10	
				COLOUR	P.10	
		TINT	P.10			
	WHITE BALANCE	P.10	—	—		
	VNR	P.17	—	—		
	SOUND	—	—	STEREO/HI	P.15	—
				AI VOLUME	P.15	—
				SOUND MODE	P.14	—
				EQUALIZER	P.15	—
				BALANCE	P.14	—
				CINEMA SURROUND	P.15	—
				MaxxBass	P.15	—
	FEATURES	DVD MENU	P.16	AUTO SIGNAL DETECT	P.16	
				DVD PICTURE MODE	P.16	
				DVD THEATER STATUS	P.16	
				DVD SOUND MODE	P.16	
		ON TIMER	P.17	PR	P.17	
		ON TIMER	P.17	—	—	
		CHILD LOCK	P.17	—	—	
		COMPRESS (16:9)	P.11	—	—	
AI ECO SENSOR/ECO MODE		P.11	—	—		
INSTALL		AUTO PROGRAM	P.19	—	—	
	EDIT/MANUAL	P.19	DELETE, MOVE, MANUAL, INSERT	P.19-P.20		
	COLOUR SYSTEM	P.9	—	—		
	LANGUAGE	P.17	LANGUAGE	P.17		
	TEXT LANGUAGE	P.13	TEXT LANGUAGE	P.13		
	VIDEO-2 SETTING	P.18	—	—		
	BLUE BACK	P.11	—	—		
PICTURE TILT	P.11	—	—			
BEEP	P.18	—	—			

# TV buttons and functions

The illustrations shown below is for AV-21BS26 and AV-29SS26 only, which are used for explanation purpose.

Your TV may not look exactly the same as illustrated.

## Front of the TV

AV-29SS26

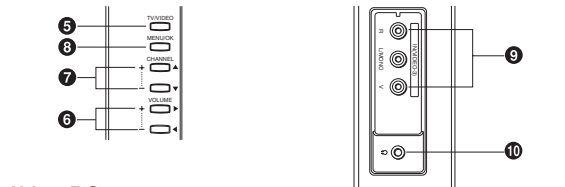
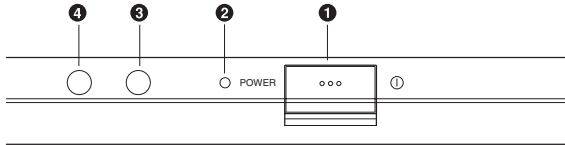

AV-21BS26

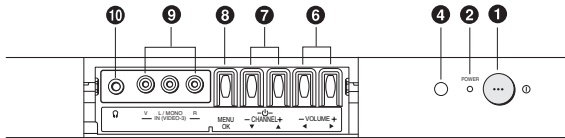

## Rear of the TV

AV-29SS26

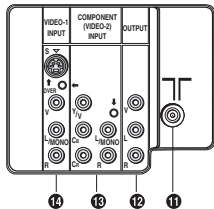

No. Button/terminal	Description	Page
① ① (main power)	Press to turn on or turn off the TV's main power.	-
② POWER lamp	Indicate the TV's status. No colour : TV's main power is being turned off. Red : TV's main power is being turned on. Blink : While the TV is in standby mode, ON TIMER function is in used. While the TV is in turn on mode, OFF TIMER function is in used. Note: When you turn off the power switch while TV is in standby mode, the power lamp will go off in 10 -15 seconds. When you operate the TV, POWER Lamp will be blink.	-
③ ECO sensor		-
④ Remote control sensor		-
⑤ TV/VIDEO	Press to select TV or Video terminal input or exit from menu.	-
⑥ VOLUME +/-	Press to adjust the volume level.	-
⑦ CHANNEL +/-	Press to select the desired channel (Both of RF and Video input.)	-
⑧ MENU/OK	Press to display the menu.	-
⑨ IN (VIDEO-3)	Video and audio input jacks for VIDEO-3 mode.	22
⑩	Headphone jack.	22
⑪	Aerial socket.	7
⑫ OUTPUT	Video and audio output jacks. (The component video signal cannot be output.)	22
⑬ COMPONENT (VIDEO-2) INPUT	Video or component video, and audio input jacks for VIDEO-2 mode. You can select the input signal by setting the "VIDEO-2 SETTING" function (see page 18).	22
⑭ VIDEO-1 INPUT	Video or S-VIDEO, and audio input jacks for VIDEO-1 mode.	7

## How to operate the menus with the TV button

TV button	Work as same as the button on the remote control unit	Note
MENU	MENU/OK button	To display main menu and exit menu after finish setting.
CHANNEL +/-	▼/▲ button	To select menu function.
VOLUME +/-	◀▶ button	To choose a Top menu and adjust the desired menu function.

# Setting up your TV

## CAUTION

- Turn off the equipment including the TV before connecting.

### 1 Connecting the aerial cable.

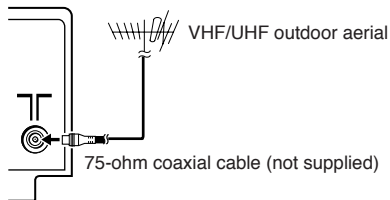

If you connect a VCR, connect the aerial output jack of your VCR and the aerial jack on the TV with aerial cable. Then connect the output jacks of your VCR and the VIDEO-1 input jacks of the TV with the video cable (or S-VIDEO cable if available) and audio cables. For details, see the manual of your VCR.

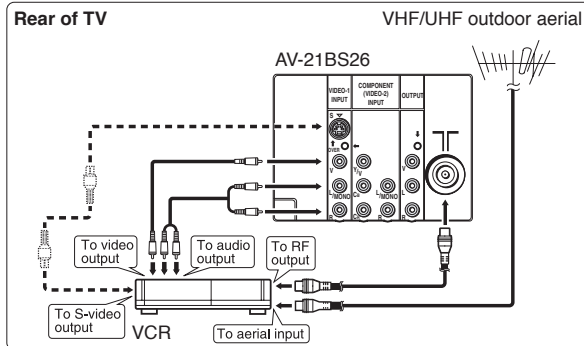

The illustration shown is just a sample. It may not be same as your TV.

### 2 Connecting the main plug to the AC outlet.

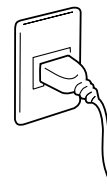

### 3 Inserting batteries into the remote control.

Insert two batteries by following the ⊕ and ⊖ polarities and inserting the ⊖ end first.

#### CAUTION:

Follow the cautions printed on the batteries.

Notes:

- Use AA/R6/UM-3 dry cell batteries.
- If the remote control does not work properly, fit new batteries. The supplied batteries are for testing, not regular use.

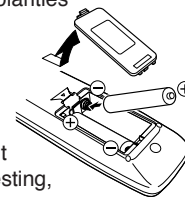

### 4 Turn on the TV by pressing the main power button.

JVC logo appears on the screen.



JVC logo will appear on the screen again at the phase of "SETUP TOUR RESTART?" function. Then the initial setting can be performed according to page 8.

#### Note:

While in the INSTALL menu with the cursor pointing at INSTALL, pressing the blue button will also display the JVC logo.

## Setting up your TV (continued)

### 5 Making the initial settings

Set up your TV by pressing MENU/OK button or waiting for 15 seconds, then operate the TV by following the steps below:



- Press ▲/▼ button to select your desired language\*.

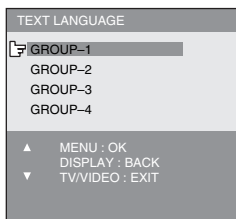

- Press ▲/▼ button to select your desired Teletext language group\*. For details, see page 13. (For BS26/MS26/SS26/MX76/SX76 series only)

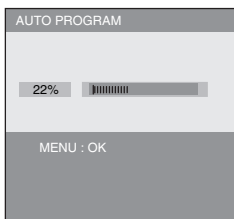

- TV will start searching for the channels.  
  
To stop AUTO PROGRAM, press MENU/OK button.

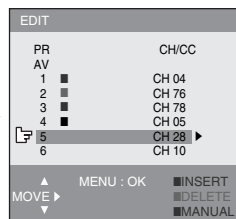

- To complete the initial setting, press the MENU/OK button. To edit the channel list, see page 19.

When turn on the TV at the next time

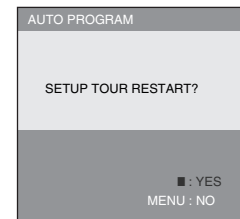

- “SETUP TOUR RESTART?” will be displayed. Press the MENU/OK button to cancel the SETUP TOUR RESTART function. If you want to make initial settings again when the next time you turn on the TV, press the Red button to activate the SETUP TOUR RESTART function.

\* If the TEXT function is available for your TV and the LANGUAGE shown follow as ENGLISH/РУССКИЙ/عربي / فارسی / FRANÇAIS, you can select the TEXT LANGUAGE group from GROUP-1 to GROUP-4.

If the TEXT function is available for your TV and the LANGUAGE shown follow as ENGLISH/РУССКИЙ/中文/MELAYU/INDONESIA, you can select the TEXT LANGUAGE group from GROUP-1 to GROUP-3.



# Basic setting for picture

## COLOUR SYSTEM

You can select the appropriate colour system when the picture is not clear or no colour appears.

Press the COLOUR SYSTEM button to select a setting.

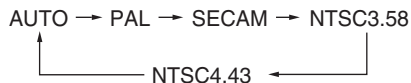

To operate this function with a menu:

\* (MENU) ➔ (INSTALL menu) ➔ (COLOUR SYSTEM)

For the colour system in each country or region, see the table below:

Area	Country or Region	System
Asia, Middle East	Bahrain, Kuwait, Oman, Qatar, United Arab Emirates, Yemen, etc.	PAL
	Indonesia, Malaysia, Singapore, Thailand, India, etc.	PAL
	China, Vietnam, etc.	PAL
	Hong Kong, etc.	PAL
	Islamic Republic of Iran, Lebanon, Saudi Arabia, etc.	SECAM
Europe	Philippines, Taiwan, Myanmar, etc.	NTSC
	Russia, etc.	SECAM
	Czech Republic, Poland, etc.	PAL
	Germany, Holland, Belgium, etc.	PAL
Oceania	UK, etc.	PAL
	Australia, New Zealand, etc.	PAL
Africa	Republic of South Africa, etc.	PAL
	Nigeria, etc.	PAL
	Egypt, Morocco, etc.	SECAM

## PICTURE MODE

You can choose the desired picture setting with one-touch.

Press the PICTURE MODE button to select a setting.

SOFT	Softens contrast and sharpness.
BRIGHT	Heightens contrast and sharpness.
STANDARD	Standard picture setting.
USER	You can change this picture setting as you like. Select USER and adjust following items in the PICTURE SETTING menu. (CONTRAST, BRIGHT, SHARP, COLOUR, TINT)

When you select VIDEO-2 Mode, you cannot adjust SHARP.

When you set DVD THEATER STATUS in DVD MENU to ON, you cannot adjust PICTURE MODE.

To operate this function with a menu:

\* (MENU) ➔ (PICTURE menu) ➔ (PICTURE MODE)

To return the USER setting to default, press the blue button when the PICTURE SETTING menu is displayed.

\* About the basic operations of the menu, please see the “How to operate menus and menus locations” on page 5.

## Basic setting for picture (continued)

### PICTURE SETTING

You can adjust the desired picture setting when selecting USER in PICTURE MODE.

1 Select USER in PICTURE MODE under PICTURE menu.

\* (MENU) → (PICTURE menu) → (PICTURE MODE)  
→ (USER)

2 Select PICTURE SETTING in PICTURE menu, then adjust the setting.

\* (MENU) → (PICTURE menu) → (PICTURE SETTING)

CONTRAST	◀ : Lower contrast	▶ : Higher contrast
BRIGHT	◀ : Darker	▶ : Brighter
SHARP	◀ : Softer	▶ : Higher
COLOUR	◀ : Lighter	▶ : Deeper
TINT	◀ : Reddish	▶ : Greenish

When you select VIDEO-2 Mode, you cannot adjust SHARP.

### WHITE BALANCE

You can change the white balance of the picture to better match the type of video being viewed.

Select WHITE BALANCE in the PICTURE menu, then choose the desired setting.

\* (MENU) → (PICTURE menu) → (WHITE BALANCE)

NORMAL	Normal white balance.
COOL	Bluish white.
WARM	Reddish white.

When you set DVD THEATER STATUS in DVD MENU to ON, you cannot adjust WHITE BALANCE.

\* About the basic operations of the menu, please see the “How to operate menus and menu locations” on page 5.

# Advanced setting for picture

## AI ECO SENSOR (ECO)/ECO MODE

You can adjust TV screen contrast according to the brightness of your room.

Press the ECO button to select the desired mode.

OFF	Cancel the function.
MODE-1/ECO-1	Mild contrast (recommended.)
MODE-2/ECO-2	Even contrast.
DISPLAY (for AI ECO SENSOR only)	Display the graphic of the function.

To operate this function with a menu:

\* (MENU) → (FEATURES menu)  
→ (AI ECO SENSOR / ECO MODE)

When you set DVD THEATER STATUS in DVD MENU to ON, you cannot adjust AI ECO SENSOR / ECO MODE.

Note : AI ECO SENSOR for M and S series.  
ECO MODE for B series.

## Correcting the Slanting Picture (PICTURE TILT)

You can correct the picture tilt caused by the earth's magnetic force.

1 Select PICTURE TILT in the INSTALL menu, then press MENU/OK button.

\* (MENU) → (INSTALL menu) → (PICTURE TILT)

The following display appears.



2 Press the ▲/▼ buttons until the picture becomes level. Then press the MENU/OK button.

## COMPRESS (16:9)

You can convert a normal picture (4:3 aspect ratio) into a wide picture (16:9 aspect ratio).

Select COMPRESS (16:9) in the FEATURES menu, then choose ON or OFF.

\* (MENU) → (FEATURES menu) → (COMPRESS (16:9))

## BLUE BACK

You can set the TV to automatically change to a blue screen and mute the sound if the signal is weak or absent, or when there is no input from an antenna.

Select BLUE BACK in the INSTALL menu, then choose ON or OFF.

\* (MENU) → (INSTALL menu) → (BLUE BACK)

If you wish to continue viewing the poor picture, off the BLUE BACK function.

\* About the basic operations of the menu, please see the "How to operate menus and menus locations" on page 5.

# Original features for picture

## PIP

You can display a sub picture within the main picture on the screen. Press the PIP operation buttons to display and change the sub picture setting.





PIP Display the sub picture.  
To cancel, press the PIP button again.

### Notes:

- You can hear the sound from the main picture only.
- When main picture and sub picture are the same TV channel.

Press SUB-P +/-	Main picture will be changed TV channel follow as sub picture.
Press  ( Input )	To change sub picture to video mode.

Press CHANNEL +/-	Sub picture will be changed TV channel follow as Main picture.
Press CHANNEL +/-	Until main picture change to video mode.

SUB-P +/-	Select the desired TV channel for sub picture.
 (Input)	Select the input source for the sub picture.
 (Swap)	Swap between the main picture and sub picture.
 (Position)	Change the sub picture position. Each time you press the  (Position) button, the sub picture position will change as follows: lower right → lower left → upper left ↑ upper right ←
 (Freeze)	Freeze the sub picture.

When VIDEO-2 is set to component, you cannot select VIDEO-2 for sub picture. If the main picture input source is VIDEO-2 with component, the PIP function is disabled.

## TELETEXT

You can watch the Teletext broadcast channel with TEXT function.



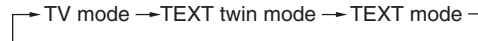









1 Press the TEXT button to select the desired mode as follows:



2 Press the CHANNEL +/- buttons, number buttons or colour buttons to select other Teletext pages.

3 Press TEXT or TV/VIDEO button to return to TV mode.

You can also operate the teletext using the following buttons:

 (Hold)	Hold a teletext page. The  (Hold) icon is displayed at the top left of the screen. To cancel, press  (Hold) button again.
 (Reveal)	Display the hidden text (e.g. answers to a quiz). To cancel, press  (Reveal) button again.
 (Size)	Enlarge the teletext display.
 (Index)	Return to the index page instantly.
 (Cancel)	Watch TV programme while waiting for a teletext page. When the teletext page is found, a page number appears at the upper left of the screen. Press  (Cancel) button to view the teletext page.
 (Sub-page)	Operate the  (Sub-page) function. Sub-page numbers are displayed at the left of the screen. To cancel sub-page function, press  (Sub-page) button again.

## Original features for picture (continued)

---

### TEXT LANGUAGE

You can set the Teletext language group that corresponds to the programmes.

Select TEXT LANGUAGE in the INSTALL menu, then choose the desired language group.

\* (MENU) → (INSTALL menu) → (TEXT LANGUAGE)

---

GROUP-1	English, German, Swedish, Finnish, Danish, Hungarian, Italian, French, Spanish, Portuguese, Turkish
GROUP-2	Polish, German, Estonian, Slovenian, Czech, Slovakian, Rumanian
GROUP-3	Polish, German, Estonian, Lettish, Russian, Ukrainian
GROUP-4	English, Polish, French, Turkish, Arabic, Farsi

---

Depending on the broadcast, the language set may not display properly. For details, refer to page 8.

\* About the basic operations of the menu, please see the “How to operate menus and menus locations” on page 5.

# Basic setting for sound

## SOUND SYSTEM

You can select an appropriate sound system when abnormal sound occurs even when the picture appears normally. Press the SOUND SYSTEM button to select a setting.

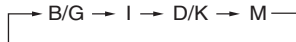

This function is not available in video mode.  
For the sound system in each country or region, see the table below:

Area	Country or Region	System
Asia, Middle East	Bahrain, Kuwait, Oman, Qatar, United Arab Emirates, Yemen, etc. Indonesia, Malaysia, Singapore, Thailand, India, etc.	B/G
	China, Vietnam, etc.	D/K
	Hong Kong, etc.	I
	Islamic Republic of Iran, Lebanon, Saudi Arabia, etc.	B/G
	Philippines, Taiwan, Myanmar, etc.	M
Europe	Russia, etc.	D/K
	Czech Republic, Poland, etc.	D/K
	Germany, Holland, Belgium, etc.	B/G
	UK, etc.	I
Oceania	Australia, New Zealand, etc.	B/G
Africa	Republic of South Africa, etc.	I
	Nigeria, etc.	B/G
	Egypt, Morocco, etc.	B/G

## SOUND MODE

You can choose the desired sound setting. Select the SOUND MODE in SOUND menu, then choose the setting.

\* (MENU) → (SOUND menu) → (SOUND MODE)

USER	You can change this sound setting as you like. Select USER and adjust the frequencies in EQUALIZER (100, 300, 1K, 3K, 8K Hz). For details, see "EQUALIZER" on page 15.
SOUND TURBO	Emphasize on low and high frequency levels.
THEATER	Emphasize on movie sound.
MUSIC	Emphasize on music effect.
NEWS	Emphasize on vocal sound.

When you select VIDEO-2, you cannot adjust SOUND MODE function. You can adjust it in DVD Menu.

When SOUND MODE is set to SOUND TURBO, EQUALIZER, CINEMA SURROUND and MaxxBass functions are not available.

## BALANCE

You can adjust the volume balance between the left and right speakers.

Select BALANCE in SOUND menu, then adjust the setting.

\* (MENU) → (SOUND menu) → (BALANCE)

\* About the basic operations of the menu, please see the "How to operate menus and menu locations" on page 5.

# Advanced setting for sound

## CINEMA SURROUND

You can enjoy an enhanced sound for wider audience.  
Press the CINEMA SURROUND button to select a setting.

OFF	Cancel the function.
ON	Listen to sound with wider audience effect.



This function is not available when SOUND MODE is set to SOUND TURBO.

To operate this function with a menu:

\* (MENU) → (SOUND menu) → (CINEMA SURROUND)

## STEREO / I-II ( I/II )

You can enjoy the stereo and bilingual broadcasted programmes.  
Press the  I/II button to select the desired mode.

	Select stereo sound.
	Select monaural sound.
I	Select bilingual I (sub I).
II	Select bilingual II (sub II).

This function is not available in video mode.

To operate this function with a menu:

\* (MENU) → (SOUND menu) → (STEREO / I-II)

## MaxxBass

You can enjoy an enhanced bass sound which cannot be reproduced by normal speakers.

Select MaxxBass in SOUND menu, then choose the desired setting.

\* (MENU) → (SOUND menu) → (MaxxBass)

OFF	MaxxBass is turned off.
HIGH	MaxxBass effect is high.
LOW	MaxxBass effect is low.

This function is not available when SOUND MODE is set to SOUND TURBO.

“MaxxBass” is a registered trademark of Waves Audio Ltd. in the USA, Japan and other countries.

## EQUALIZER

You can adjust the sound level of each frequencies when selecting USER mode in SOUND MODE.

1 Select USER in SOUND MODE under SOUND menu.

\* (MENU) → (SOUND menu) → (SOUND MODE) → (USER)

2 Select EQUALIZER in SOUND menu.

\* (MENU) → (SOUND menu) → (EQUALIZER)

The following display appears.

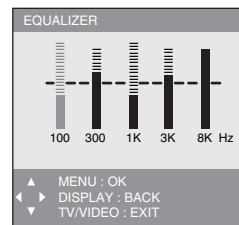

3 Select and adjust the desired frequencies.

4 Press the MENU/OK button to exit the menu.

Adjust high frequency will affect higher pitch sound and vice versa.  
When you select VIDEO-2, you cannot adjust EQUALIZER.

## AI VOLUME

You can adjust the volume of all the channels and video inputs to the same level automatically depends on the strength of signal of the sources.

Select AI VOLUME in SOUND menu, then choose ON or OFF.

\* (MENU) → (SOUND menu) → (AI VOLUME)

\* About the basic operations of the menu, please see the “How to operate menus and menus locations” on page 5.

# DVD Menu

## AUTO SIGNAL DETECT

When the DVD input signal is detected, the input mode will be changed to VIDEO-2 automatically. And when the DVD input signal is not detected, the input mode will be changed to RF previous input mode.

Select AUTO SIGNAL DETECT in DVD MENU under FEATURES menu then choose ON or OFF (Factory setting is ON).

\* (MENU) → (FEATURES menu) → (DVD MENU)  
→ (AUTO SIGNAL DETECT)

Press the “POWER ON” button on the DVD players or VCRs (follow by the “PLAY” button for VCRs) so that the signal can be detected.

## DVD PICTURE MODE

You can enhance the picture quality of the DVD or VIDEO-2.

Select DVD PICTURE MODE in DVD MENU under FEATURES menu, then choose the desired setting.

\* (MENU) → (FEATURES menu) → (DVD MENU)  
→ (DVD PICTURE MODE)

OFF	Cancel the function.
CLEAR-1	Select when the disc is with lots of noise (To soften the picture).
CLEAR-2	Select when the disc is with less noise (To sharpen the picture).

## DVD THEATER STATUS

You can enjoy an enhanced picture quality for movie playback in a dark room, like watching a movie in the theater.

Select DVD THEATER STATUS in DVD MENU under FEATURES menu, then choose ON or OFF.

\* (MENU) → (FEATURES menu) → (DVD MENU)  
→ (DVD THEATER STATUS)

ON	Enjoy movie playback with suitable colour temperature, sharp subtitles and improved gradation for black, like in a theater.
OFF	Cancel the function.

When you set DVD THEATER STATUS to ON, PICTURE MODE, WHITE BALANCE and AI ECO SENSOR / ECO MODE functions are not available.

## DVD SOUND MODE

You can choose different sound setting for viewing different types of DVD content.

Select DVD SOUND MODE in DVD MENU under FEATURES menu, then choose the desired setting.

\* (MENU) → (FEATURES menu) → (DVD MENU)  
→ (DVD SOUND MODE)

MUSIC	Select when watching a music concert.
USER	Select if you want to adjust the sound setting to your preference.
THEATER	Select when watching an action movie.
DRAMA	Select when watching a drama movie.

\* About the basic operations of the menu, please see the “How to operate menus and menu locations” on page 5.



# Customized setting

## VNR

You can reduce the picture noise.

Select VNR in PICTURE menu, then choose a setting of VNR function.

\* (MENU) → (PICTURE menu) → (VNR)

OFF	VNR is turned off.
AUTO	Effect of VNR is automatically controlled.
MIN	Effect of VNR becomes minimum level.
MAX	Effect of VNR becomes maximum level.

If you select MAX, the picture becomes softer even if the original picture is sharp.

When you select VIDEO-2, you cannot adjust VNR function.

## LANGUAGE

You can choose your desired on screen display language.

Select LANGUAGE in the INSTALL menu, then choose a language.

\* (MENU) → (INSTALL menu) → (LANGUAGE)

## CHILD LOCK

You can disable the front control buttons of the TV.

Select CHILD LOCK in the FEATURES menu, then choose ON or OFF.

\* (MENU) → (FEATURES menu) → (CHILD LOCK)

## ON TIMER

You can set the TV to turn on automatically from standby mode at a set channel and time.

1 Select ON TIMER in the FEATURE menu.

\* (MENU) → (FEATURES menu)  
→ (ON TIMER)

The following display appears.

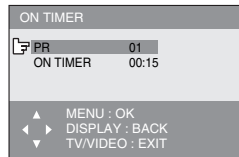

2 Choose the PR (channel) by pressing the ◀/▶ button.

External input, AV position and any un-preset channel cannot be chosen for PR.

3 Set the ON TIMER to your desired period of time by pressing the ◀/▶ button. ON TIMER starts. You can set the period of time to a maximum of 12 hours in 15-minute intervals.

To off the ON TIMER, set the ON TIMER to OFF.

Note : If TV is not in standby mode when ON TIMER is reach the setting time, this case is not available.

## OFF TIMER

You can set the TV to turn off automatically to standby mode after a set time.

Press the OFF TIMER button to select a desired period of time.

You can set the period of time to a maximum of 120 minutes in 10 minute intervals.

To operate this function with a menu:

\* (MENU) → (FEATURES menu) → (OFF TIMER)

When the remaining elapse time is one minute, "GOOD NIGHT!" appears on the screen.

You can display the OFF TIMER menu again to confirm or change the remaining time.

\* About the basic operations of the menu, please see the "How to operate menus and menus locations" on page 5.

## Customized setting (continued)

### VIDEO-2 SETTING

You can set the VIDEO-2 SETTING according to the video signal output from external devices connected to the VIDEO-2 terminal. Select VIDEO-2 SETTING in INSTALL menu, then choose a setting (Factory setting is COMPONENT).

\* (MENU) → (INSTALL menu) → (VIDEO-2 SETTING)

VIDEO	If a normal video signal (composite video signal) is input.
COMPONENT	If a component video signal (Y/C <sub>B</sub> /C <sub>R</sub> ) is input.

You must choose a setting according to the signal that you input to VIDEO-2. (If you input the VIDEO Signal or VCR Signal to VIDEO-2, you must set VIDEO-2 SETTING to VIDEO.)

For connecting methods, see “Additional Preparation” on page 22.

### BEEP

You can use the BEEP function to alert you during DVD AUTO SIGNAL DETECT, AI ECO SENSOR Detect, Stereo Detect, ON TIMER/OFF TIMER operations and when some buttons on the remote control are pressed.

Select BEEP in the INSTALL menu, then choose ON or OFF.

\* (MENU) → (INSTALL menu) → (BEEP)

When the volume is level 0, then BEEP function is not available.

### DISPLAY

You can display the programme number, video terminal number and PR list on the screen.

Press the DISPLAY button to select the desired mode:



Choose a TV channel or a VIDEO terminal.

- 1 Press the DISPLAY button to display the PR LIST.
- 2 Select a programme number or video terminal by pressing the ▲/▼ button to move up/down on the programme number or press the ◀▶ button to skip for each 7 programme numbers, then press MENU/OK button.

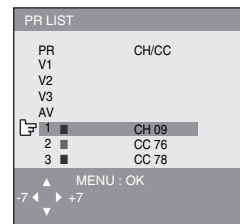

\* About the basic operations of the menu, please see the “How to operate menus and menu locations” on page 5.

# TV channel presetting

## To register the TV channels automatically (AUTO PROGRAM)

You can register the TV channels into the TV's channel list automatically.

- 1 Display the INSTALL menu.

\* (MENU) ➔ (INSTALL menu)

- 2 Choose AUTO PROGRAM, then press the MENU/OK button. AUTO PROGRAM function starts, and the channels received are registered in the channel list (PR LIST) automatically.

- 3 The EDIT menu appears.

To edit the channel list	Proceed to Step 3 of "To edit the channel list (PR LIST)" on page 20.
If a channel is not registered	Proceed to Step 3 of "To register the TV channels manually" on this page.
To exit the menu	Press the MENU/OK button.

## To register the TV channels manually (MANUAL in the EDIT menu)

You can register the TV channels into the TV's channel list manually.

- 1 Display the INSTALL menu.

\* (MENU) ➔ (INSTALL menu)

- 2 Choose EDIT/MANUAL, then press the MENU/OK button. EDIT menu appears.

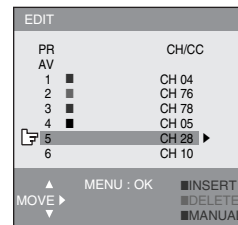

- 3 Choose the channel which you want to register.
- 4 Press the blue button to activate the MANUAL function. The sound system of the channel appears at the right of the CH/CC number.
- 5 Press the ► button to choose an appropriate sound system. For details, see "SOUND SYSTEM" on page 14.
- 6 Press the green or red button to search for the TV channel. Searching stops when a channel is found and displayed.
- 7 Repeat step 5 until your desired TV channel appears.

If the reception is poor	Press the blue or yellow button to fine tune the TV channel.
If noisy sound is heard	Press the ► button to choose an appropriate sound system.

- 8 Press the MENU/OK button to exit the menu.

\* About the basic operations of the menu, please see the "How to operate menus and menu locations" on page 5.

## TV channel presetting (continued)

### To edit the channel list (PR LIST) (MOVE and DELETE in the EDIT menu)

You can edit the TV channel list as you like.

Note: After this operation, other channel's PR numbers will be changed.

- 1 Display the INSTALL menu.

\* (MENU) ➔ (INSTALL menu)

- 2 Choose EDIT/MANUAL, then press the MENU/OK button.  
EDIT menu appears.

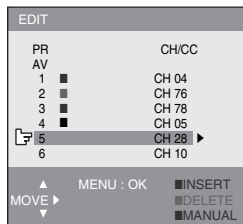

- 3 Choose the channel which you want to change its PR number, or delete.

- 4 Do the following action:

---

To change the PR number (MOVE)	Press the ► button. Then move it to the new PR number you want to use for the channel by pressing the ▲/▼ button. Finally press the ◀ button.
--------------------------------	---

---

To delete the channel (DELETE)	Press the yellow button.
--------------------------------	--------------------------

---

- 5 Press the MENU/OK button to exit the menu.

### To add in the new channel (INSERT in the EDIT menu)

You can add in new channels in the TV channel list as you like.

You need to find the “CH/CC” number for the TV channel. Find the “CH/CC” number corresponding to the channel number of the TV channel from “CH/CC number list” on page 21.

- 1 Display the INSTALL menu.

\* (MENU) ➔ (INSTALL menu)

- 2 Choose EDIT/MANUAL, then press the MENU/OK button.  
EDIT menu appears.

- 3 Choose the PR number for which you will register a new TV channel. When you add a new TV channel of NTSC-M system, press the SOUND SYSTEM button to change the sound system to M. Then proceed to the next step.

- 4 Press the green button, then press ► button to choose “CC” or “CH”.

- 5 Press the number button to enter the CH/CC number for the TV channel you wish to add.

The TV starts to search the TV channel, and the picture of the TV channel appears. If the TV finds no TV channel, a noisy picture appears.

When a TV channel has already been registered in PR99, using the INSERT function deletes that TV channel.

\* About the basic operations of the menu, please see the “How to operate menus and menus locations” on page 5.

## TV channel presetting (continued)

### CH/CC number

When you want to use the INSERT function on page 20, find the CH/CC number corresponding to the channel number of the TV channel from this table.

Channel No.	Country
US	United States, Philippines, etc..
CCIR	Middle East, Southeast Asia, etc..
OIRT	Eastern Europe, Russia, Vietnam, etc..
AUSTRALIA	Australia, etc..

### Channel

CH	US	CCIR	OIRT	AUSTRALIA
CH 02	US-2	E2	R1	AU-0
CH 03	US-3	E3		AU-1
CH 04	US-4	E4	R2	AU-2
CH 05	US-5	E5	R6	AU-6
CH 06	US-6	E6	R7	AU-7
CH 07	US-7	E7	R8	AU-8
CH 08	US-8	E8	R9	AU-9
CH 09	US-9	E9		
CH 10	US-10	E10	R10	AU-10
CH 11	US-11	E11	R11	AU-11
CH 12	US-12	E12	R12	
CH 13	US-13			
CH 14	US-14, W+29			
CH 15	US-15, W+30			
CH 16	US-16, W+31			
CH 17	US-17, W+32			
CH 18	US-18, W+33			
CH 19	US-19, W+34			
CH 20	US-20, W+35			
CH 21	US-21, W+36	E21		
CH 22	US-22, W+37	E22		
CH 23	US-23, W+38	E23		
CH 24	US-24, W+39	E24		
CH 25	US-25, W+40	E25		
CH 26	US-26, W+41	E26		
CH 27	US-27, W+42	E27		
CH 28	US-28, W+43	E28		AU-28
CH 29	US-29, W+44	E29		AU-29
CH 30	US-30, W+45	E30		AU-30
CH 31	US-31, W+46	E31		AU-31/AU-32
CH 32	US-32, W+47	E32		AU-33

CH	US	CCIR	OIRT	AUSTRALIA
CH 33	US-33, W+48	E33		AU-34
CH 34	US-34, W+49	E34		AU-35
CH 35	US-35, W+50	E35		AU-36
CH 36	US-36, W+51	E36		AU-37
CH 37	US-37, W+52	E37		AU-38
CH 38	US-38, W+53	E38		AU-39/AU-40
CH 39	US-39, W+54	E39		AU-41
CH 40	US-40, W+55	E40		AU-42
CH 41	US-41, W+56	E41		AU-43
CH 42	US-42, W+57	E42		AU-44
CH 43	US-43, W+58	E43		AU-45
CH 44	US-44, W+59	E44		AU-46
CH 45	US-45, W+60	E45		AU-47/AU-48
CH 46	US-46, W+61	E46		AU-49
CH 47	US-47, W+62	E47		AU-50
CH 48	US-48, W+63	E48		AU-51
CH 49	US-49, W+64	E49		AU-52
CH 50	US-50, W+65	E50		AU-53
CH 51	US-51, W+66	E51		AU-54
CH 52	US-52, W+67	E52		AU-55/AU-56
CH 53	US-53, W+68	E53		AU-57
CH 54	US-54, W+69	E54		AU-58
CH 55	US-55, W+70	E55		AU-59
CH 56	US-56, W+71	E56		AU-60
CH 57	US-57, W+72	E57		AU-61
CH 58	US-58, W+73	E58		AU-62
CH 59	US-59, W+74	E59		AU-63/AU-64
CH 60	US-60, W+75	E60		AU-65
CH 61	US-61, W+76	E61		AU-66
CH 62	US-62, W+77	E62		AU-67
CH 63	US-63, W+78	E63		AU-68
CH 64	US-64, W+79	E64		AU-69
CH 65	US-65, W+80	E65		
CH 66	US-66, W+81	E66		
CH 67	US-67, W+82	E67		
CH 68	US-68, W+83	E68		
CH 69	US-69, W+84	E69		

CC	US	CCIR	OIRT	AUSTRALIA
CC 01		S-1		AU-5
CC 02		S-2		
CC 03		S-3		
CC 04		S-4		
CC 05		S-5		
CC 06		S-6		AU-5A
CC 07		S-7		
CC 08		S-8		
CC 09		S-9		
CC 10		S-10		
CC 11		S-11		
CC 12		S-12		
CC 13		S-13		
CC 14	A	S-14		
CC 15	B	S-15		
CC 16	C	S-16		
CC 17	D	S-17		

CC	US	CCIR	OIRT	AUSTRALIA
CC 18	E	S-18		
CC 19	F	S-19		
CC 20	G	S-20		
CC 21	H	S-21		
CC 22	I	S-22		
CC 23	J	S-23		
CC 24	K	S-24		
CC 25	L	S-25		
CC 26	M	S-26		
CC 27	N	S-27		
CC 28	O	S-28		
CC 29	P	S-29		
CC 30	Q	S-30		
CC 31	R	S-31		
CC 32	S	S-32		
CC 33	T	S-33		
CC 34	U	S-34		
CC 35	V	S-35		
CC 36	W	S-36		
CC 37	W+1	S-37		
CC 38	W+2	S-38		
CC 39	W+3	S-39		
CC 40	W+4	S-40		
CC 41	W+5	S-41		
CC 42	W+6			
CC 43	W+7			
CC 44	W+8			
CC 45	W+9			
CC 46	W+10			
CC 47	W+11			
CC 48	W+12			
CC 49	W+13			
CC 50	W+14			
CC 51	W+15			
CC 52	W+16			
CC 53	W+17			
CC 54	W+18			
CC 55	W+19			
CC 56	W+20			
CC 57	W+21			
CC 58	W+22			
CC 59	W+23			
CC 60	W+24			
CC 61	W+25			
CC 62	W+26			
CC 63	W+27			
CC 64	W+28			
CC 75		X		
CC 76		Y	R3	
CC 77		Z	R4	AU-3
CC 78		Z+1	R5	
CC 79		Z+2		AU-4
CC 95	A-5			
CC 96	A-4			
CC 97	A-3			
CC 98	A-2			
CC 99	A-1			

# Additional preparation

The illustrations shown in this section are for AV-21BS26 and AV-29SS26 only, which are used for explanation purpose. Your TV may not look exactly the same as illustrated.

## Before connecting

- Read the manuals provided with the devices for the proper connection.
- Turn off all the devices including the TV.
- Note that connecting cables are not supplied.

## Connecting to front video input terminals

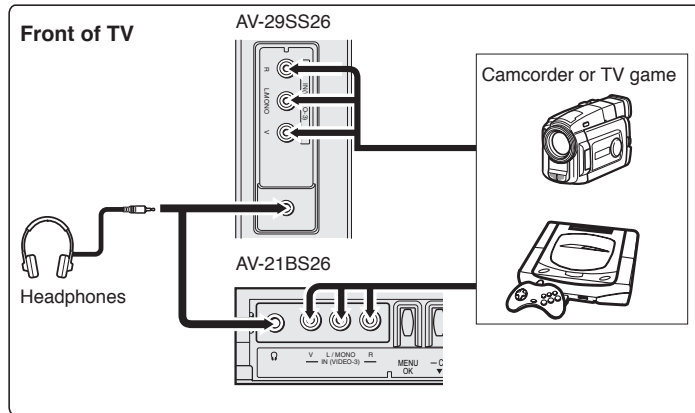

## Connecting to rear component/video input terminals and output terminals

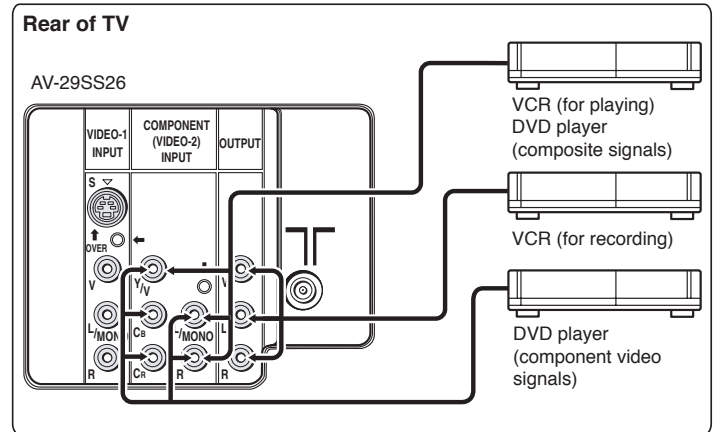

When connecting to COMPONENT (VIDEO-2) input, depending on the connection, choose the appropriate video input using the menu (see "VIDEO-2 SETTING" on page 18)

# Troubleshooting

If a problem occurs when you are using the TV, check the below troubleshooting guide before calling for repair.

• No picture, no sound	• Deactivate the BLUE BACK function if it is turned on. • Choose the appropriate sound system. Refer to "SOUND SYSTEM" on page 14.
• Snowy picture	• Check the aerial cable and its connection with the TV.
• Stripes appear on the picture	• Interference occurs caused by other devices such as an amplifier, personal computer, or a hair drier. Move such devices away from your TV.
• Double-pictures (ghosting) occur	• Interference occurs caused by signal reflecting from mountains or building. Try to adjust the aerial's direction or use a better directionality antenna.
• Poor picture	• Choose the appropriate colour system. Refer to "COLOUR SYSTEM" on page 9. • Adjust the COLOUR or BRIGHT setting. Refer to "PICTURE SETTING" on page 10.
• White and bright still image look as if it were coloured	• Inevitable phenomenon due to the nature of the picture tube. This is not a malfunction.
• Top of the image from software products or video tape is distorted	• This is due to the condition of the video signal whereby the image was not recorded properly. This is not a malfunction.
• Poor sound	• Adjust the sound frequency properly. Refer to "EQUALIZER" on page 15.
• Stereo or bilingual sound is unclear	• TV channel reception is poor. Change the stereo/bilingual mode to mono sound (see page 15).
• Cannot operate the remote control	• The batteries may be exhausted. Replace with new batteries (see page 7). • Ensure that you are operating the remote control at less than seven meters from the front of your TV.
• Cannot operate the menus	• Press TV/VIDEO button to return to TV mode and try operating the menus.
• Cannot operate the front control buttons	• Deactivate the CHILD LOCK function if it is turned on (see page 17).

• Colour patches appear at the corner of the screen	• This may due to the magnetized device such as a speaker near to your TV. Keep the device apart from your TV. Alternately, you can also use the magnetic-shielded speaker.
• Picture is tilted	• This may due to the earth magnetism. Refer to "PICTURE TILT" on page 11 to correct the tilt.
• Image takes a short period to be displayed	• Image required time to stabilize before display. This is not a malfunction.
• TV may emit crackling sound	• This is due to a sudden change in temperature and it is not a malfunction. If the crackling sound is too frequent, request your service technician for inspection.
• Feel a slight electric shock when touching the TV screen	• This is due to the static electricity of the picture tube and it will not harm the human body. This is not a malfunction.
• The Auto Signal Detect function does not work	• Please check that the AUTO SIGNAL DETECT function is on or off. • Turn the VCR or DVD player off, wait a while, then turn it on again. • Inspect the video cable connection on VIDEO-2 that they are connected properly.
• Suddenly, a channel or input was changed to VIDEO-2 inputs.	• Some VCRs and DVD players can trigger Auto Signal Detect even after you choose a different input. • Please turn off the AUTO SIGNAL DETECT function.
• "PLEASE DISCONNECT VIDEO-1 CABLE!" appears on the screen.	• Please disconnect either S-VIDEO cable or video input cable from Video-1 input.

# Specifications

---

## TV RF systems

B, G, I, D, K, M

## Colour systems

PAL, SECAM, NTSC 3.58 MHz, NTSC 4.43 MHz

## Receiving channels

VHF low channel (VL), VHF high channel (VH), UHF channel (U)  
Receives cable channels in mid band, super band and hyper band.

## Power requirements

For Australia: AC 220 to 240 V, 50 Hz / 60 Hz

For others: AC 110 to 240 V, 50 Hz / 60 Hz

## External input / output

VIDEO-1: S-video input, VIDEO input, AUDIO L/R input

VIDEO-2/COMPONENT: VIDEO input, AUDIO L/R input, COMPONENT VIDEO (Y/C<sub>B</sub>/C<sub>R</sub>) input

VIDEO-3: VIDEO input, AUDIO L/R input

OUTPUT: VIDEO output, AUDIO L/R output

Headphone jack: Stereo mini jack (3.5 mm diameter)

## \*\*Sound-multiplex systems

A2 (B/G) or NICAM (B/G, I, D/K)

## \*\*Teletext system

FLOF (Fastext), WST (World Standard Text)

## \*\*Language displayed by teletext

Please see the table in the description "TEXT LANGUAGE" on page 13.

---

\*\*Depends on the models, STEREO/II function for the Sound-multiplex systems or Teletext function may not be available.

Please confirm with the chart on page 3.

***Design and specifications subject to change without notice.***

# JVC